

CATALOGUE 07.2022



The company Mobilex A/S was founded in 2003 and since then offers a wide range of aids for handicapped and disabled people like wheelchairs, walking aids and rollators, ramps, bath products and miscellaneous spare parts.

We distribute our products throughout Europe and serve our customers through our own sales representatives.

High quality standards, modern technology, fast delivery, a customer-oriented service and highly motivated employees are the key of our success.

We look forward to a pleasant cooperation.

Mobilex A/S
Grønlandsvej 5
DK-8660 Skanderborg
Denmark

Tel. +45 8793 2220
Fax +45 8793 1777
www.mobilex.dk

VAT number DK 27147720

Bank connection:

Nordea Denmark
Frederiks Plads 40
DK-8000 Aarhus C

SWIFT/BIC: NDEADKKK
IBAN: DK1420005036669073



Ladies and Gentlemen,

We are pleased to present you with our catalogue. We would be very grateful for any criticism, suggestions for changes or positive feedback.

In the catalogue our products are shown and provided with short descriptions. Each picture has its own number (e.g. B6). The corresponding article numbers can be found in the price list. You may use these pictures also on your own web page.

We try to keep a standard assortment on stock. For goods outside the standard assortment we ask you to accept a short delivery time.

For further information please refer to our sales and delivery conditions on the following pages.

The satisfaction of our customers is very important to us. Therefore we always try to offer a flawless and customer-oriented service. Should you have any reason for complaint, please contact our CEO Mr. Thomas Nygaard Christensen and let us know your feedback. We are always striving to improve our services.

With kind regards



Thomas Nygaard Christensen
CEO

Page	Leaflet	Description
7 - 18	A / F	Front wheels and Tente castors
19 - 34	B	Tyres and puncture proof solutions
35 - 56	C .. CZ	Large wheels, accessories, Spinergy®, pushrims, one-hand drive and drum brake set
57 - 66	D .. DX	Accessories, silicone covers, spoke guards etc.
67 - 72	DZ	PU moulded parts - armrests, headrests, side supports and leg spreaders
73 - 76	E	Raised toilet seats and soft covers
77 - 80	G	Pressure-relieving mattresses
81 - 88	H / HX	Dolphin and Barracuda wheelchairs
89 - 94	P	Seat cushions and swivel cushions
95 - 100	PTe	Textile products
101 - 106	PTr	Transfer and positioning products
107 - 112	PX	Levabo® positioning cushions
113 - 116	J	Batteries and chargers
117 - 126	L	Wheelchair ramps
127 - 132	LX	Threshold ramps of rubber or aluminium
133 - 136	M	Therapy tables
137 - 140	N	Grab bars and support handles
141 - 148	OX	Bathing products
149 - 154	OY	"Kakadu" Commode and shower chairs
155 - 158	Q	Other aids - Pedal trainers, crutches etc.
159 - 192	RI .. RBi	Indoor- and outdoor-rollators, arthritis rollators, walking frames and Shopping trolleys
193 - 194	SP	Marketing materials

We make reservations for errors in prices and misprints

Prices

The prices will be invoiced according to the valid price list. We reserve the right to change prices at any time, but normally we only change prices at the end of the year or in special cases with one-month notice.

Payment / Credit Limit

Standard payment term for first orders is prepayment. A payment period of 30 days net from the invoice date then is possible by agreement. In this case we grant a credit limit. Should this limit be exceeded by new orders, we reserve the right to make the delivery only after payment of the delivered orders. We do not grant discount deduction, not even with advance or cash payment. If earlier invoices have not been paid on time, we reserve the right to withhold deliveries until payment has been settled. In the event of invoices not paid on time, we reserve the right to charge interest of 1% per month commenced and a fee of €10 to cover our costs.

Delivery

Mobilex A/S ships all goods at the expense and risk of the customer. If Mobilex A/S sends the goods free of charge, the customer bears the shipping risk.

User manuals

CE marked products are supplied with user manuals in Danish, German, English or Italian. In countries outside these language areas, it is the dealers' duty to request the document file from Mobilex A/S and to arrange for the translation into the relevant language.

Retention of title

All delivered goods remain the property of Mobilex A/S until full payment has been received.

Complaints / right of return

The customer is obliged to check the goods on receipt for completeness and damage. If damage to a shipment is already visible on the packaging, the shipment should only be accepted with reservation. Complaints must be made in writing to Mobilex A/S within 8 days. A right of return exists only if appropriate agreements have been made with Mobilex A/S beforehand and the goods are returned unused, undamaged and in their original packaging. The return costs shall be borne by the customer. If the item is not in its original packaging, it is the responsibility of the customer to properly secure the item prior to shipment and to ensure that there is no visible damage to the product. After receipt and inspection, Mobilex A/S will credit the customer with the price of the product minus 30€ for the missing original packaging. Free delivered goods will be credited minus the freight originally paid by Mobilex A/S. Should clean of the product be necessary, Mobilex A/S reserves the right to charge the customer for the costs incurred.

Force majeure

In case of force majeure Mobilex A/S is entitled to cancel or delay the delivery. In these cases, the customer cannot claim damages.

Liability

Mobilex A/S is only liable for late delivery in accordance with the Danish Commercial Code. The customer cannot claim compensation for loss of business, loss of earnings or other losses. Possible compensation, if any, can only be made in the amount of the purchase price. Mobilex A/S is entitled to exchange the goods in question or to send spare parts for repair in the event of delivery of faulty goods. If Mobilex A/S is unable to exchange the goods, Mobilex A/S shall only be liable in accordance with the Danish Commercial Code. However, there is no entitlement to compensation for loss of business or earnings or other indirect losses. Possible compensation, if any, can only be made in according to the amount of the purchase price.

Product liability

Mobilex A/S is exempt from any product liability, except the mandatory provisions of the Danish Product Liability Act. However, there is no claim for damages for loss of business or earnings or other indirect losses.

Data protection — collection and use of data

The information we receive from you helps us to secure and continuously improve your good customer experience at Mobilex A/S. We use the information about your company to process your orders, create and ship order confirmations, deliver ordered goods, notify you of new products and changes, and process payments. We also collect and store information about previous orders in order to track the goods delivered when needed. If you would like to review the information we hold about your company or have it corrected or deleted, please contact Mobilex A/S. Mobilex A/S does not pass on customer data to third parties.

Place of jurisdiction and applicable law

In case of legal disputes, the place of jurisdiction is Horsens in Denmark. All disputes are subject to Danish law.

FRONT WHEELS



Leaflet A and F

Front wheels and Tente castors

A: Front wheels, distance bushings, bolts etc.

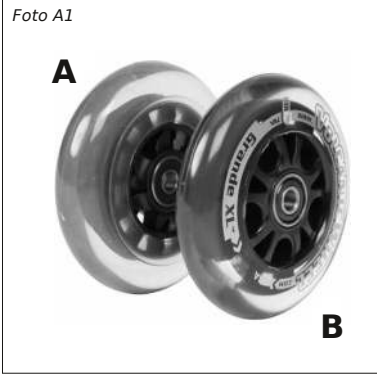

3", 4" or 5" Skater wheel with (B) or without LED (A)



3", 4", 5" or 6" Aluminium wheel with black rubber tyre



Aluminium wheel 4" or 5" rubber tyre



Aluminium wheel 5" with pneumatic tyre

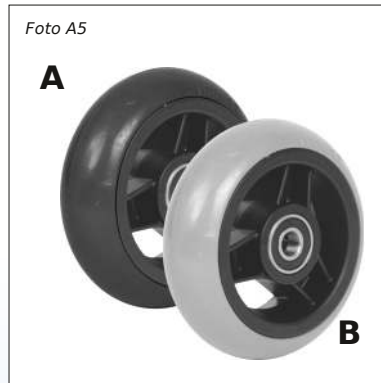

4" Plastic wheel with narrow or wide rubber tyre



5" Plastic wheel with wide rubber tyre

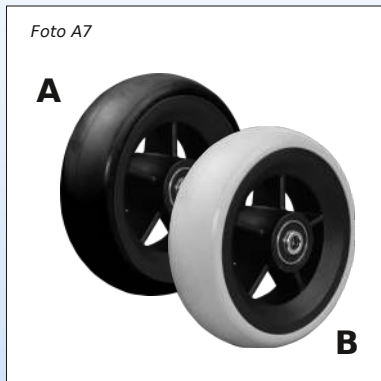

5" wheel with wide rubber tyre 125 x 40

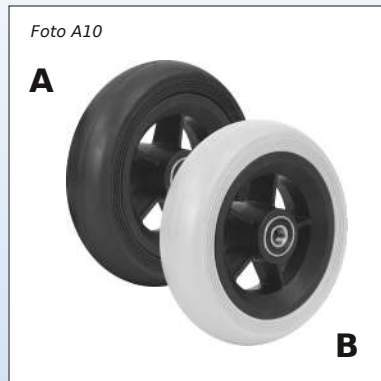

5.5" wheel with wide round rubber tyre



6" x 1 1/4" wheel with PU tyre



5", 6", 7", 8" wheel with round rubber tyre



6", 7", 8" wheel with wide rubber tyre

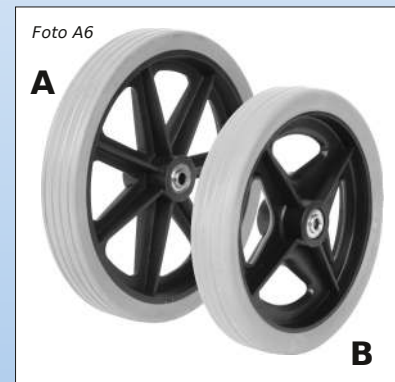

7" (A), 8" (B) wheel with flat rubber tyre

Foto A13



7" x 3/4", 200 x 45 wheel with polyurethane tyre

Foto A14



8" x 1 1/4" wheel with PU tyre

Foto A18



8" x 1 1/4" wheel with Flexel or pneumatic tyre

Foto A16



6", 150 x 30 wheel with polyurethane tyre for "Jazzy" chair

Foto A17



6" x 1 1/4" or 7" x 1 1/4" wheel with Flexel or pneumatic tyre

Foto A34



7" wheel 178 x 56 mm with split rim and PU tyre

Foto A15



8" Flexel wheel, 200 x 50, off-set hub Ø12 x 60 mm

Foto A19



200 x 50 wheel with Flexel or pneumatic tyre

Foto A20



7 x 1 3/4" or 8" (200 x 50) wheel with split rim and Flexel tyre

Foto A26



8", 7", 6", 5", 4" and 3" black fibre wheels with black tyre

Foto A27



Fibre wheels in Spinergy spoke colours with black tyre

Foto A42



200 x 50 wheel with PU tyre
Only available in boxes of 40 pcs.



Box with 16 PU wheels 200 x 50



Box with 40 PU wheels 200 x 50



12" wheel with polyurethane tyre for sideways fitting 12"



12" PU wheel with drum brake



12" wheel with Flexel or pneumatic tyre



16" drum brake wheel with Flexel tyre



5" or 6.5" wheel with dark grey rubber tyre for ETAC chairs

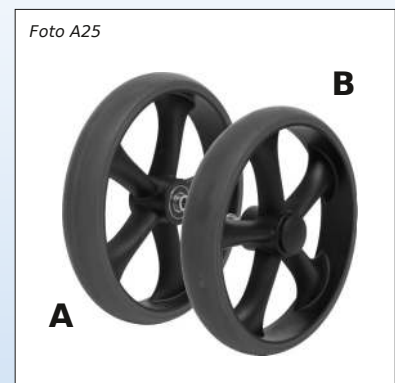

8" 200 x 35 mm wheel with rubber tyre for rollators (A:front, B:rear)

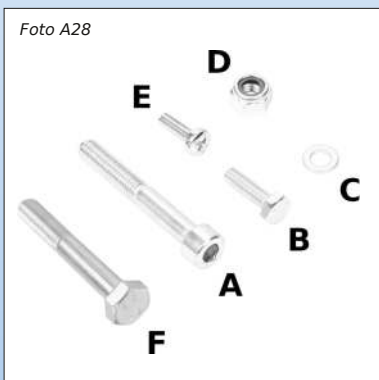

Bolts, nuts etc.



Box with distance bushings or spacers



Spacers and distance bushings

Castor with plain bearings. Used for bed-tables or other purposes with a low load.
We have 2 types on stock $\varnothing 50$ mm and $\varnothing 75$ mm with or without brake.



Castor model 2470 with plain bearings



Castor model 2475 with plain bearings with brake

Castor with ball-bearings. Used for beds or other purposes with a high load.
We have different sizes on stock from $\varnothing 75$ mm to $\varnothing 150$ mm with or without brake.



Castor model 2470 with ball-bearings



Castor model 2477 with ball-bearings

Castor with total brake for hospital beds. There is one model with total brake only and one model with total and directional brake. Available with ordinary or antistatic wheels.



Castor for beds, model 2474/76



astor for beds, model 2044/46

Foto F7



100 mm / 125 mm wheel with brake or Aquatec shower-chair

Foto F8



Twin wheel castor model 2970 without brake

Foto F9



Plastic wheel model 5897 with brake, has small swing radius for lifter

Foto F10



Castor model 2740 with brake

Foto F11



Plastic wheel model 5387 with brake for shower chairs etc.

Foto F12



Pipe in stainless steel for mounting of wheels on shower chairs

Small wheels / front wheels

Item nr.	Description	Foto	Hub	Load	Price
201021	50 mm antitip wheel black nylon, hub 10 mm	A1C	10 mm	--	2,25 €

Item nr.	Description	Foto	Hub	Load	Price
201031	3" Skater wheel 75 x 25 mm	A1A	25 mm	40 kg	6,50 €
201043	4" Skater wheel 100 x 25 mm	A1A	25 mm	40 kg	8,50 €
201053	5" Skater wheel 125 x 25 mm	A1A	25 mm	40 kg	11,50 €

201032	3" Volcanic Wheel skaterwheel 75 x 25 mm with LED	A1B	25 mm	40 kg	31,00 €
201044	4" Volcanic Wheel skaterwheel 100 x 25 mm with LED	A1B	25 mm	40 kg	36,00 €
201057	5" Volcanic Wheel skaterwheel 125 x 25 mm with LED	A1B	25 mm	40 kg	40,50 €
201067	6" Volcanic Wheel skater wheel 145 x 30 mm with LED	A1B	25 mm	40 kg	48,00 €

Item nr.	Description	Foto	Hub	Load	Price
201046	4" Aluminium wheel with spokes, 100 x 22 mm, rubber profile	A3	25 mm	40 kg	64,00 €
201054	5" Aluminium wheel with spokes, 125 x 22 mm, rubber profile	A3	25 mm	40 kg	73,00 €

20103A	3" Aluminium wheel silver, 80 x 34 mm, black rubber tyre, hub ø8 x 25 mm	A2D	25 mm	40 kg	32,00 €
20104A	4" Aluminium wheel silver, 100 x 34 mm, black rubber tyre, hub ø8 x 25 mm	A2C	25 mm	40 kg	41,50 €
20105A	5" Aluminium wheel silver, 125 x 34 mm, black rubber tyre, hub ø8 x 25 mm	A2B	25 mm	40 kg	49,00 €
20106A	6" Aluminium wheel silver, 150 x 34 mm, black rubber tyre, hub ø8 x 25 mm	A2A	25 mm	40 kg	77,00 €

20104B	4" Aluminium wheel, black, 100 x 34 mm, black rubber tyre, hub ø8 x 25 mm	A26C	25 mm	40 kg	38,50 €
20105B	5" Aluminium wheel, black, 120 x 34 mm, black rubber tyre, hub ø8 x 25 mm	A26B	25 mm	40 kg	48,00 €
20106B	6" Aluminium wheel, black, 150 x 34 mm, black rubber tyre, hub ø8 x 25 mm	A26A	25 mm	40 kg	70,00 €

Item nr.	Description	Foto	Hub	Load	Price
201034	3" Fibre wheel, black, 75 x 34 mm, black tyre, hub ø8 x 25 mm	A26D	25 mm	40 kg	24,50 €
201047	4" Fibre wheel, black, 100 x 34 mm, black tyre, hub ø8 x 25 mm	A26C	25 mm	40 kg	27,50 €
201056	5" Fibre wheel, black, 125 x 34 mm, black tyre, hub ø8 x 25 mm	A26B	25 mm	40 kg	30,00 €
201063	6" Fibre wheel, black, 150 x 34 mm, black tyre, hub ø8 x 25 mm	A26A	25 mm	40 kg	31,00 €
201074	7" Fibre wheel, black, 175 x 34 mm, black tyre, hub ø8 x 25 mm	A26E	25 mm	40 kg	31,50 €
201088	8" Fibre wheel, black, 200 x 34 mm, black tyre, hub ø8 x 25 mm	A26F	25 mm	40 kg	32,00 €

20104C	4" Fibre wheel, white, 100 x 34 mm, black tyre, hub ø8 x 25 mm	A27	25 mm	40 kg	27,50 €
20104D	4" Fibre wheel, yellow, 100 x 34 mm, black tyre, hub ø8 x 25 mm	A27	25 mm	40 kg	27,50 €
20104E	4" Fibre wheel, orange, 100 x 34 mm, black tyre, hub ø8 x 25 mm	A27	25 mm	40 kg	27,50 €
20104F	4" Fibre wheel, red, 100 x 34 mm, black tyre, hub ø8 x 25 mm	A27	25 mm	40 kg	27,50 €
20104G	4" Fibre wheel, blue, 100 x 34 mm, black tyre, hub ø8 x 25 mm	A27	25 mm	40 kg	27,50 €
20104H	4" Fibre wheel, green, 100 x 34 mm, black tyre, hub ø8 x 25 mm	A27	25 mm	40 kg	27,50 €

Item nr.	Description	Foto	Hub	Load	Price
20105C	5" Fibre wheel, white, 125 x 34 mm, black tyre, hub ø8 x 25 mm	A27	25 mm	40 kg	30,00 €
20105D	5" Fibre wheel, yellow, 125 x 34 mm, black tyre, hub ø8 x 25 mm	A27	25 mm	40 kg	30,00 €
20105E	5" Fibre wheel, orange, 125 x 34 mm, black tyre, hub ø8 x 25 mm	A27	25 mm	40 kg	30,00 €
20105F	5" Fibre wheel, red, 125 x 34 mm, black tyre, hub ø8 x 25 mm	A27	25 mm	40 kg	30,00 €
20105G	5" Fibre wheel, blue, 125 x 34 mm, black tyre, hub ø8 x 25 mm	A27	25 mm	40 kg	30,00 €
20105H	5" Fibre wheel, green, 125 x 34 mm, black tyre, hub ø8 x 25 mm	A27	25 mm	40 kg	30,00 €

20106C	6" Fibre wheel, white, 150 x 34 mm with black tyre, hub width ø8 x 25 mm	A27	25 mm	40 kg	31,00 €
20106D	6" Fibre wheel, yellow, 150 x 34 mm with black tyre, hub width ø8 x 25 mm	A27	25 mm	40 kg	31,00 €
20106E	6" Fibre wheel, orange, 150 x 34 mm with black tyre, hub width ø8 x 25 mm	A27	25 mm	40 kg	31,00 €
20106F	6" Fibre wheel, red, 150 x 34 mm with black tyre, hub width ø8 x 25 mm	A27	25 mm	40 kg	31,00 €
20106G	6" Fibre wheel, blue, 150 x 34 mm with black tyre, hub width ø8 x 25 mm	A27	25 mm	40 kg	31,00 €
20106H	6" Fibre wheel, green, 150 x 34 mm with black tyre, hub width ø8 x 25 mm	A27	25 mm	40 kg	31,00 €

Mobilex A/S - Price list

All prices are per pcs. and in EUR.

07.2022

Leaflet A

Item nr.	Description	Foto	Hub	Load	Price
203051	5" Pneumatic aluminium wheel, 125 x 30 mm, hub ø8 x 26 mm	A4	26 mm	40 kg	84,00 €
203061	6" Pneumatic wheel, 150 x 30 mm	A17	32 mm	40 kg	31,00 €
203071	7" Pneumatic wheel, 175 x 45 mm	A17	41 mm	40 kg	39,50 €
203072	7" Pneumatic wheel, 175 x 45 mm, split rim with bushes for 60 mm fork	A20	60 mm	40 kg	41,50 €
203081	8" Pneumatic wheel, 200 x 30 mm	A18	37 mm	40 kg	38,50 €
203082	8" Pneumatic wheel, 200 x 50 mm, split rim with bushes for 60 mm fork	A19	60 mm	40 kg	40,50 €
203083	8" Pneumatic wheel, 200 x 50 mm split rim with distance bushes for 60 mm fork	A20	60 mm	40 kg	43,50 €
203121	12 1/2" x 2 1/4" pneumatic with patterned tyre and tube	A24	48 mm	40 kg	68,00 €

Item nr.	Description	Foto	Hub	Load	Price
201041	4" Rubber wheel, 100 x 26 mm, round profile	A5B	26 mm	40 kg	15,00 €
201042	4" Rubber wheel, 100 x 32 mm, wide profile	A5B	32 mm	40 kg	16,00 €
201045	4" Rubber wheel, 100 x 32 mm, wide black profile	A5A	32 mm	40 kg	19,00 €
201051	5" Rubber wheel, 125 x 27 mm, round profile	A8	32 mm	40 kg	16,00 €
201059	5" Rubber wheel, 125 x 27 mm, round black profile	A26	32 mm	40 kg	20,00 €
201055	5" Rubber wheel, 125 x 30 mm, black flat profile for Etac, hub 56 mm	A21	56 mm	40 kg	33,00 €
201052	5,5" Rubber wheel, 140 x 40 mm, flat profile	A10B	41 mm	40 kg	21,50 €
20105K	5,5" Rubber wheel, 140 x 40 mm, flat black profile	A10A	41 mm	40 kg	21,50 €
20105L	5" Rubber wheel, 125 x 40 mm, round profile	A7B	41 mm	40 kg	21,50 €
20105S	5" Rubber wheel, 125 x 40 mm, black round profile	A7A	41 mm	40 kg	21,50 €
201058	5" rubber wheel, 125 x 34 mm, flat tyre	A9	32 mm	40 kg	19,00 €
201061	6" Rubber wheel, 150 x 27 mm, round profile	A8	32 mm	40 kg	18,00 €
201062	6" Rubber wheel, 150 x 33 mm, flat profile	A11	32 mm	40 kg	20,00 €
201065	6,5" Rubber wheel, 165 x 30 mm, black flat profile for Etac, hub 56 mm	A21	56 mm	40 kg	34,00 €
201071	7" Rubber wheel, 175 x 27 mm, round profile	A8	37 mm	40 kg	20,00 €
201072	7" Rubber wheel, 175 x 33 mm, flat profile	A11	37 mm	40 kg	22,50 €
201073	7" rubber wheels, 185 x 30 mm, flat profile, incl. distance bushing, 45 mm width	A6A	43 mm	40 kg	15,00 €
201081	8" Rubber wheel, 200 x 33 mm, flat profile	A11	37 mm	40 kg	23,50 €
201082	8" Rubber wheel, 200 x 27 mm, round profile	A8	37 mm	40 kg	22,50 €
201083	8" Rubber wheels, 200 x 30 mm, flat profile for rollator	A6B	43 mm	40 kg	17,00 €
201085	8" Rubberwheel, 200 x 35 mm, for Rollator, frontwheel, incl. bolt and nut	A25A	60 mm	40 kg	20,00 €
201086	8" Rubberwheel, 200 x 35 mm, for Rollator, rearwheel, incl. bolt and nut	A25B	32 mm	40 kg	22,50 €

Item nr.	Description	Foto	Hub	Load	Price
202061	6" Polyurethane wheel, 150 x 30 mm	A12	32 mm	40 kg	22,50 €
202062	6" Polyurethane wheel, 150 x 30 mm, 26 mm hub for Jazzy	A16	26 mm	40 kg	42,50 €
202071	7" Polyurethane wheel, 175 x 45 mm, incl. distance bushings for 60 mm fork	A13	60 mm	40 kg	25,50 €
202072	7" Polyurethane wheel, 175 x 45 mm with rilled PU-tyre	A15	41 mm	40 kg	26,50 €
202073	7" Polyurethane wheel, 178 x 56 mm, split rim, grooved	A34	60 mm	40 kg	32,00 €
202081	8" Polyurethane wheel, 200 x 30 mm	A14	37 mm	40 kg	23,50 €
202083	8" Polyurethane wheel, 200 x 45 mm, with distance bushes for 60 mm fork	A13	60 mm	40 kg	29,00 €
202082	8" Polyurethane wheel, 200 x 50 mm, with distance bushes for 60 mm fork	A15	60 mm	40 kg	29,00 €
202085	8" Polyurethane wheel, 200 x 50 mm, ø10 x 41 mm hub		60 mm	40 kg	26,50 €
202086	8" Polyurethane wheel, 200 x 50 mm, with distance bushes for 60 mm fork	A41	60 mm	40 kg	23,50 €
D0020	Box with 40 pcs PU-wheels 200 x 50 (202086)	A41	60 mm	40 kg	682,00 €
202084	Box with 16 pcs 8" PU-wheels, 200 x 50 mm, hub 60 mm	A40	60 mm	40 kg	234,00 €
202089	8" rollator wheel with closed rim, ø8 x 60 mm hub, box with 40 pcs.	A42	60 mm	40 kg	317,00 €
202121	12" PU wheel, 300 x 45 mm, ø12 x 37/48, off-set hub	A22	48 mm	40 kg	44,50 €
202124	12" PU wheel, 300 x 45 mm, ø12 x 55 mm, symmetric hub	A22	54 mm	40 kg	54,00 €
202122	12" PU wheel, 300 x 45 mm, with drumbrake and ø12 x 114 mm axle, right	A35	---	40 kg	102,00 €
202123	12" PU wheel, 300 x 45 mm, with drumbrake and ø12 x 114 mm axle, left	A35	---	40 kg	102,00 €

Item nr.	Description	Foto	Hub	Load	Price
204061	6" Flexel wheel, 150 x 30 mm, grooved	A17	32 mm	40 kg	27,50 €
204071	7" Flexel wheel, 175 x 45 mm, grooved	A17	41 mm	40 kg	39,50 €
204072	7" Flexel wheel, 175 x 45 mm, split rim, with distance bushes for 60 mm fork	A20	60 mm	40 kg	46,00 €
204081	8" Flexel wheel, 200 x 30 mm, grooved	A18	37 mm	40 kg	41,50 €
204082	8" Flexel wheel, 200 x 50 mm, grooved	A19	41 mm	40 kg	46,00 €
204085	8" Flexel wheel, 200 x 50 mm, split rim, with distance bushes for 60 mm fork	A20	60 mm	40 kg	50,00 €
204121	12 1/2" x 2 1/4" Flexel wheel with 37/48 mm off-set hub	A24	48 mm	40 kg	79,00 €
204122	12 1/2" x 2 1/4" Flexel wheel with 54 mm hub	A24	54 mm	40 kg	80,00 €
204161	16" drumbrake wheel with tyre and flexe, ø12 x 70 mm hub - side A (left)	A23	---	40 kg	157,00 €
204162	16" drumbrake wheel with tyre and flexel, ø12 x 70 mm hub - side B (right)	A23	---	40 kg	157,00 €

Table for the selection of bushings and spacers.

Please note that our wheels are supplied without spacers. Below you will find a table for adapting the spacers to the fork widths.

See next pages for prices.

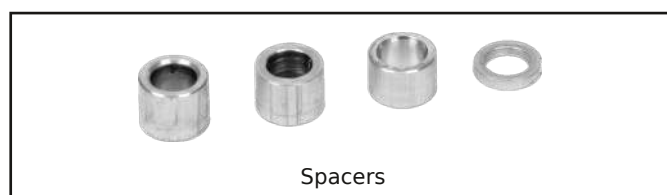
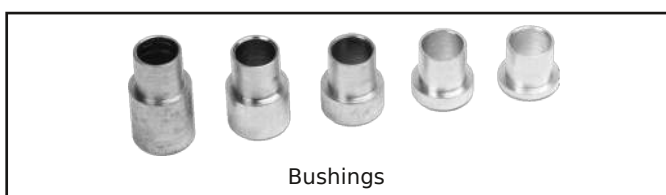

Item nr.	Wheeltype	Bearing ø mm	Hub width	Bushing for hub width ...				
				36 mm	40 mm	45 mm	53 mm	60 mm
20103A..6A	Alu wheel silver 3", 4", 5" , 6"	8 mm	25 mm	228104	228106	228109		
20104B..6B	Alu wheel black 4", 5" 6"	8 mm	25 mm	228104	228106	228109		
201034	Rubber wheel 3", 80 x 34	8 mm	25 mm	228104	228106	228109		
201031..2	Skater wheel 3", 75 x 25	8 mm	24 mm	228105	228107	228109		
201043..4	Skater wheel 4", 100 x 25	8 mm	24 mm	228105	228107	228109		
201034	Rubber wheel 3", 80 x 34	8 mm	25 mm	228104	228106	228109		
201047	Rubber wheel 4", 100 x 34	8 mm	25 mm	228104	228106	228109		
201056	Rubber wheel 5", 125 x 34	8 mm	25 mm	228104	228106	228109		
201063	Rubber wheel 6", 150 x 34	8 mm	25 mm	228104	228106	228109		
201046	Alu wheel 4", 100 x 22	8 mm	25 mm	228104	228106	228109		
201054	Alu wheel 5", 125 x 22	8 mm	25 mm	228104	228106	228109		
201053	Skater wheel 5", 125 x 25	8 mm	25 mm	228104	228106	228109		
201056	Rubber wheel 5", 125 x 34	8 mm	25 mm	228104	228106	228109		
20104C..6H	Fiber wheel color 4" or 5"	8 mm	25 mm	228104	228106	228109		
201041	Rubber wheel 4" 100 x 26	10 mm	26 mm	228008	228014	228004	228005	
201042	Rubber wheel 4" 100 x 32	10 mm	32 mm	228001	228002	228003	228004	228005
201051	Rubber wheel 5" 125 x 26	10 mm	32 mm	228001	228002	228003	228004	228005
201052+5K+5L	Rubber wheel 5.5" 140 x 40	10 mm	41 mm			228001	228003	228004
201063	Rubber wheel 6", 150 x 34	10 mm	25 mm	228104	228106	228109		
201058	Rubber wheel 5" 125 x 34	10 mm	32 mm	228001	228002	228003	228004	228005
201061	Rubber wheel 6" 150 x 27	10 mm	32 mm	228001	228002	228003	228004	228005
201062	Rubber wheel 6" 150 x 33	10 mm	32 mm	228001	228002	228003	228004	228005
201071	Rubber wheel 7" 175 x 27	10 mm	37 mm		228001	228002	228011	228004
201072	Rubber wheel 7" 175 x 33	10 mm	37 mm		228001	228002	228011	228004
201081	Rubber wheel 8" 200 x 33	10 mm	37 mm		228001	228002	228011	228004
201082	Rubber wheel 8" 200 X 27	10 mm	37 mm		228001	228002	228011	228004
202061	Polyurethan 6" 150 x 30	10 mm	32 mm	228001	228002	228003	228004	228005
202071	Polyurethan 7" 175 x 45	10 mm	54 mm					228016
202072	Polyurethan 7" 175 x 45	10 mm	41 mm	228002		228001	228003	228004
202081	Polyurethan 8" 200 x 30	10 mm	37 mm		228001	228002	228011	228004
203051	5" Alu-pneu., 125 x 30 mm	8 mm	26 mm	228104	228106	228109		
203061	Pneu. wheel 6" 150 x 30	10 mm	32 mm	228001	228002	228003	228004	228005
203071	Pneu. wheel 7" 175 x 45	10 mm	41 mm			228001	228003	228004
203081	Pneu. wheel 8" 200 x 30	10 mm	37 mm		228001	228002	228011	228004
204061	Flexel wheel 6" 150 x 30	10 mm	32 mm	228001	228002	228003	228004	228005
204071	Flexel wheel 7" 175 x 45	10 mm	41 mm			228001	228003	228004
204081	Flexel wheel 8" 200 x 30	10 mm	37 mm		228001	228002	228011	228004
204082	Flexel wheel 8" 200 x 50	10 mm	41 mm				228003	228004

Distance bushings

Item nr.	Description	Foto	Price
228001	Distance bushing 2 x ø8 mm	A30	0,50 €
228016	Distance bushing 3 x ø8 mm	A30	0,50 €
228002	Distance bushing 4 x ø8 mm	A30	0,50 €
228008	Distance bushing 5 x ø8 mm	A30	0,50 €
228003	Distance bushing 6 x ø8 mm	A30	0,50 €
228014	Distance bushing 7 x ø8 mm	A30	0,50 €
228011	Distance bushing 8 x ø8 mm	A30	0,80 €
228004	Distance bushing 10 x ø8 mm	A30	0,90 €
228012	Distance bushing 12 x 8 mm	A30	0,90 €
228005	Distance bushing 14 x ø8 mm	A30	0,80 €
228006	Distance bushing 2 x ø6 mm	A30	0,50 €
228009	Distance bushing 4 x ø6 mm	A30	1,00 €
228015	Distance bushing 6 x ø6 mm	A30	0,50 €
228010	Distance bushing 8 x ø6 mm	A30	0,50 €
228017	Distance bushing Etac, ø6 x 7.5 mm	A30	1,50 €
228007	Distance bushing Etac, ø6 x 12 mm	A30	1,00 €
228020	Distance bushing 2 x ø9 mm for 12 mm bearing	A30	1,00 €
228202	Distance bushing 3 x ø8 mm for 12 mm bearing	A30	7,50 €

Item nr.	Description	Foto	Price
228101	Spacer 2 x ø8 mm	A31	0,60 €
228102	Spacer 3 x ø8 mm	A31	0,60 €
228103	Spacer 4 x ø8 mm	A31	0,60 €
228104	Spacer 5 x ø8 mm	A31	0,60 €
228105	Spacer 6 x ø8 mm	A31	0,60 €
228106	Spacer 7 x ø8 mm	A31	0,80 €
228107	Spacer 8 x ø8 mm	A31	0,80 €
228108	Spacer 9 x ø8 mm	A31	0,80 €
228109	Spacer 10 x ø8mm	A31	0,80 €

228098	Box with 200 various bushings	A29	94,00 €
228099	Box with 200 various distance spacers	A29	89,00 €

Spacers, screws, washers, lock nuts and bolts

Item nr.	Description	Foto	Price
229021	Axle set, M8 x 40 mm	A28	0,60 €
229022	Axle set, M8 x 45 mm	A28	0,60 €
229023	Axle set, M8 x 60 mm	A28	0,60 €
229004	Locknut M4, bag with 10 pcs	A28D	1,00 €
229005	Locknut M5, bag with 10 pcs	A28D	1,00 €
229006	Locknut M6, bag with 10 pcs	A28D	1,50 €
229008	Locknut M8, bag with 10 pcs	A28D	1,50 €
229105	Washer ø5, bag with 10 pcs	A28C	1,00 €
229106	Washer ø6, bag with 10 pcs	A28C	1,00 €
229108	Washer ø8, bag with 10 pcs	A28C	1,50 €
229512	Screw M5 x 12 mm, bag with 10 pcs	A28E	2,25 €
229516	Screw M5 x 16 mm, bag with 10 pcs	A28E	2,25 €
229525	Screw M5 x 25 mm, bag with 10 pcs.	A28E	2,75 €
229530	Screw M5 x 30 mm, bag with 10 pcs	A28E	3,25 €
229540	Screw M5 x 40 mm, bag with 10 pcs.	A28E	3,25 €
229625	Cylinderheaded bolt M6 x 25 mm, bag with 10 pcs	A28A	3,25 €
229630	Cylinderheaded bolt M6 x 30 mm, bag with 10 pcs	A28A	3,75 €
229655	Cylinderheaded bolt M8 x 55 mm, for plastic frontfork, 45 mm, bag with 10 pcs	A28A	5,25 €
229670	Cylinderheaded bolt M8 x 70 mm, for plastic frontfork, 60 mm, bag with 10 pcs	A28A	7,50 €
229690	Cylinderheaded bolt, M8 x 90 mm, bag with 10 pcs.	A28A	8,50 €
229820	Bolt M6 x 20 mm, bag with 10 pcs.	A28B	3,25 €
229825	Bolt M8 x 25 mm, bag with 10 pcs	A28B	3,75 €
229830	Bolt M6 x 30 mm, bag with 10 pcs	A28B	3,25 €
229840	Bolt M6 x 40 mm, bag with 10 pcs	A28B	3,25 €
229841	Bolt M8 x 40 mm, bag with 10 pcs	A28B	4,25 €
229860	Bolt M6 x 60 mm, bag with 10 pcs	A28B	4,25 €
229861	Bolt M8 x 60 mm, bag with 10 pcs	A28B	4,25 €
229865	Bolt M8 x 65 mm, bag with 10 pcs	A28B	4,25 €
229880	Bolt M8 x 80 mm, bag with 10 pcs	A28B	6,50 €

Tente castors

Item nr.	Description	Load	Height	Hole	Foto	Price
250021	ø50 mm wheel, with slide bearing, 2470 PJI 050 P30	50	69	Ø10	F1	13,00
250031	ø75 mm wheel, with roller bearing, 2470 PJI 075 P30	75	100	Ø10	F1	14,00
250022	ø50 mm wheel, with roller bearing and brake, 2475 PJI 050 P30	50	69	Ø10	F2	21,50
250032	ø75 mm wheel, with rollerbearing and brake, 2470 PJI 075 P30	75	100	Ø10	F2	24,50
250033	ø75 mm wheel, with ball bearing, 2470 PJP 075 P30	75	100	Ø10	F3	22,50
250034	ø75 mm wheel, with roller bearing and brake, 2477 PJP 075 P30	75	100	Ø10	F4	29,00
250036	Swingable black wheel ø75 mm with ballbearing, ø10 mm hole, 2470 PJP 075 P30	75	100	Ø10	F10	39,50
250041	ø100 mm wheel, with ball bearing, 2470 PJP 100 P30	100	135	Ø10	F3	25,50
250051	ø125 mm wheel, with ball bearing	100	160	Ø10	F3	29,00
250061	ø150 mm wheel, with ballbearing, 2470 PJP 150 P30	100	185	Ø10	F3	60,00
250071	ø75 mm wheel with ball bearing, 11 PJP 075	75	--	--	F3	13,00
250072	ø100 mm wheel with ball bearing, 11 PJP 100	100	--	--	F3	16,00
250073	ø125 mm wheel with ball bearing, 11 PJP 125	100	--	--	F3	20,00
250042	ø100 mm wheel, with ball bearing and brake, 2470 PJP 100 P30	100	135	Ø12	F4	32,00
250052	ø125 mm wheel, with ball bearing and brake, hole 12 mm, 2477 PJP 125 P30	100	160	Ø12	F4	33,00
250062	ø150 mm wheel, with ballbearing and brake, 2477 PJP 150 P30	100	185	Ø12	F4	81,00
250047	ø100 mm wheel for beds, total-brake, high stem, 2476 PJP 100 R26-28S45	80	138	Ø10	F5	92,00
250057	ø125 mm wheel for beds, total-brake, high, high stem, 2476 PJP 125 R26-28S45	100	163	--	F5	113,00
250058	ø125 mm wheel for beds, total-brake, high, low stem, 2476 PJP 125 R36-28S45	100	163	--	F5	89,00
250065	ø150 mm wheel for hospital beds, directionbrake, 2044 UAP 150 R26-28S	150	183	--	F6	164,00
250066	ø150 mm wheel for hospital beds, direction brake, antistatic, 2044 XSX 150 R26-28S45	150	183	--	F6	173,00
250067	ø150 mm wheel for hospital beds, total brake, 2046 UAP 150 R26-28S	150	183	--	F6	167,00
250068	ø150 mm wheel for hospital beds, total brake, antistatic, 2046 XSX 150 R26-28S45	150	183	--	F6	178,00
250044	Mannerwheel ø100 mm with brake	100	140	Ø12	F7	33,00
250054	Mannerwheel ø125 mm with brake	100	160	Ø12	F7	39,50
250064	Mannerwheel ø150 mm	100	180	Ø12	F7	47,00
250035	Double swingable wheel ø75 mm with ball bearing 2970 PJP 075 P30	100	99	Ø10	F8	29,00
250046	ø100 mm plastic wheel with brake, with ball bearing for lifts	100	135	Ø12	F9	34,00
250049	Swivel ø100 mm wheel from plastic with brake and stainless ballbearings for bathchairs	100	133	Ø12	F11	31,00
250058	Swivel ø125 mm wheel from plastic with brake for bath chairs	100	158	Ø12	F11	38,50

Accessories for castors

Item nr.	Description	Foto	Price
250201	Stainless tube ø19 mm for castor, 180 mm long with 7 ø6 mm holes and M12 hole in bottom	F12	14,00
250904	Round-headed screw, 12 x 45mm. stainless steel	F13	2,25
250905	Bolt M12 x 25 mm. Stainles steel	F13	1,50
250906	Bolt M10 x 25 mm. Stainles steel	F13	1,00
250101	ø10 x 6 mm spacer for ø75 wheel Item.no: 250036		2,25
250990	Reduction bushing from plastic	F14	0,20
250991	Expander for tube ø19-21,5 mm	F15	10,50

TYRES TYRES



Leaflet B

Tyres and puncture proof solutions

Patterns of pneumatic tyres

B1. Standard tyres for rear wheels on manually operated wheelchairs



B1a

B1b

B1c

B1d

B1e

B2. Kenda wheelchair tyres



B2a. Kenda K-191 Konzept

The Kenda **K-191 Konzept** is an excellent all-purpose and sports tyre. It offers excellent acceleration and turning characteristics.

B2b. Kenda K-196

The Kenda **K-196 Kontender** is specially designed for the active and fast moving wheelchair user. It has a smooth centre profile for higher speeds and water-repellent grooves for wet conditions.

B2c. Kenda K-1053 Kwik Trax

The Kenda **K-1053 Kwik Trax** is specially designed for casual everyday driving. The Kwik Trax is the ideal tyre for all weather conditions.

B3. Tufo tubular tyres



The tubeless **Tufo** tyres have a specially designed side wall that after inflation sticks on to the rim and do not slip on it. Most of the tyre stays inside the rim and is in that way protected from side impact damages. No gluing to the rim is required.

B4. CST VN Master Protect



The **VN Master Alpha Protect** with PlatinumShield puncture protection combines the advantages of a 3mm LDP rubber layer with a layer of tightly woven and extra light EPS polyfibre. This multi-layer structure provides optimal puncture protection for wheelchair tyres. It has a smooth-running and comfortable profile and is easy to install due to the lack of required directional mounting.

B5. Tyres for electric wheelchairs

Overview of tire profiles for electric wheelchairs or scooters

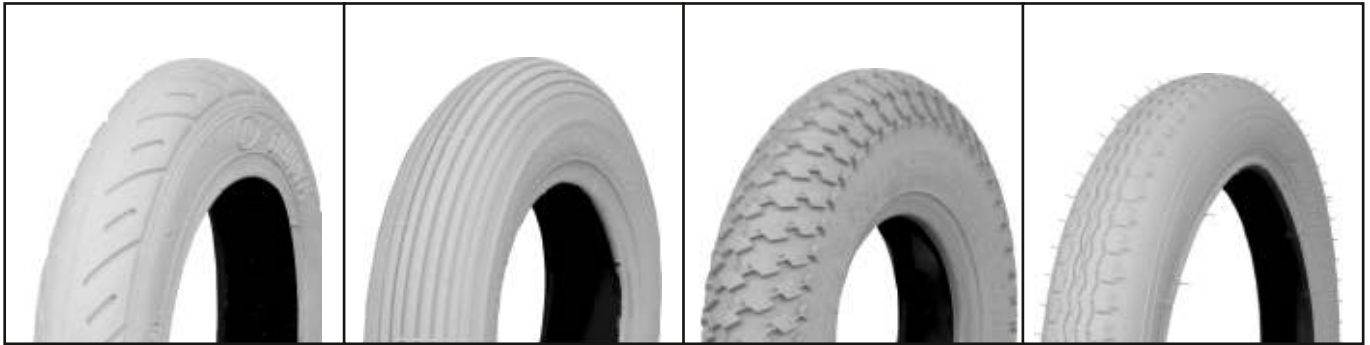

B5a. IA-2613

B5b. C-179 / IA-2801

B5c. C-968

B5d. IA-2601



B5e. C-628 / IA-2814

B5f. C-920

B5g. C-179

B5h. IA-2817



B5i. C-248 / IA-2805

B5j. C-154 / IA-2815

B5k. C-156

B5l. IA-2804



B5m. C-917

B5n. C-165 / C-9266

B5o. C-168

B5p. C-166



B5q. C-177

B5r. C-248 low

B5s. C-131

B5t. C-97

B6. Schwalbe wheelchair tyres



B6a. Marathon Evolution / Marathon+

The all-new version comes with improved rolling resistance. In addition, the SmartGuard protection belt is made from a proportion of recycled natural rubber. The "anti-aging" sidewall construction can withstand the typical overloading from insufficient inflation pressure for much longer. Also with the dynamic new profile and new look label.



B6b. Downtown

Effective puncture protection layer, hand-friendly 2-grip side wall and visually very attractive two-tone rubber compound. The special feature is the robust Black'n rolling compound in the tread center.



B6c. Rightrun und Rightrun+

Entry level tyre, but packed with features: Effective puncture protection layer, hand-friendly 2Grip side walls, and attractive two color compound. Robust Black'n Roll tread center compound that is nonmarking neatly completes the feature list.



B6d. Schwalbe One

The name alone indicates how significant this tyre is for Schwalbe. It is the fastest and at the same time most reliable wheelchair tyre they have ever made. It is manufactured in a separate facility built exclusively for the production of this new top-class tyre.



B6e. Durano

The popular Durano has a completely new profile and is now 10 grams lighter. Remain does its outstanding qualities obtained by: Extremely high mileage. Dual Compound for best adhesion also training on wet winter roads. Proven Race Guard protection belt.



B6f. Lugano

Attractive bi-color compound. The classic diamond profile provides reliable performance on dry and wet roads.



B6g. Speed Air

The indoor specialist. Exceptionally nimble and easy running. The center tread is asymmetrically designed to match the wheel camber angle of indoor wheelchairs.



B6i. LandCruiser

The offroad wheelchair tyre. Landcruiser is suitable for occasional off road use. Note: The inside diameter of this 24" tyre is 507 mm. So it is not compatible with the usual 24" wheelchair rim size of 540 mm. Ensure that both the rim and tyre sizes are compatible i.e. 507mm.



B6j. Marathon Plus Tour

Whether asphalt or natural road, the versatile tyre is at home on all paths. In everyday life or on the grand tour. The robust construction puts everything away. Safe thanks to SmartGuard, the most effective protective belt available for wheelchair tires.

B7. Offroad tyres



B7a. Standard Offroad tyre



B7b. Schwalbe Black Jack



B6i. Schwalbe LandCruiser



B7d. CST Offroad



B7e. Kenda Nevegal



B7f. PR1MO Knobby

Type of valves



Presta valve

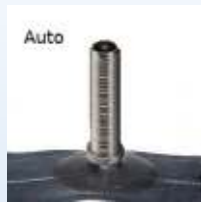

Auto valve

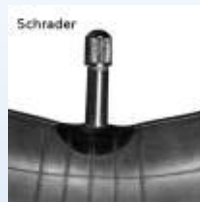

Schrader
Straight valve



90°/30° valve

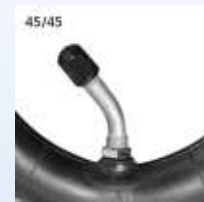

45°/45° valve

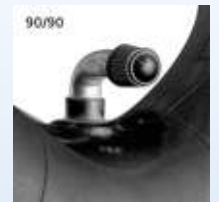

90°/90° valve

Puncture proof solutions

B8. Patterns of polyurethane tyres

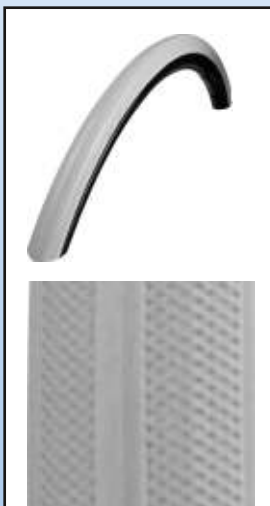

B8a

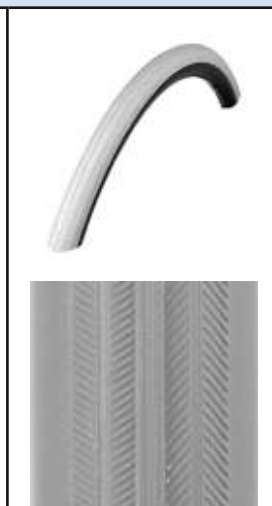

B8b

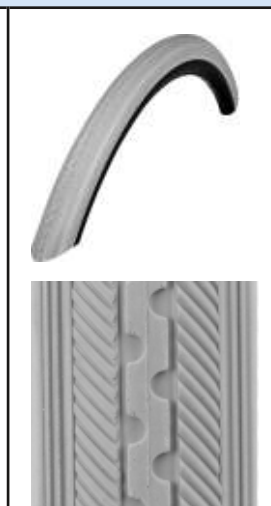

B8c



B8d

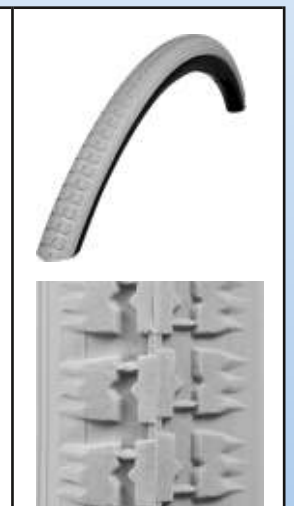

B8e

B9. Flexel INSERT



B9a. Flexel with lip



B9b. Flexel without lip

Flexel Insert is used instead of the tube. Flexel insert offers a comfortable drive without the risk of punctures. We recommend the use of Flexel insert with our tyres to make sure that they fit optimally. Flexel insert has the advantage that it can be reused.

B10. Flexel INFILL

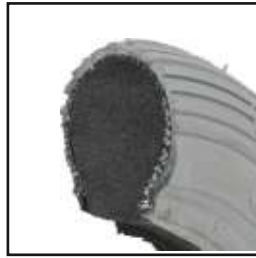

B10a. Flexel (section)



B10b. Flexel standard



B10c. Flexel Light

Flexel Infill is a tyre that are filled with Flexel. These tyres are used with two-part rims. They can not be reused.

We supply Flexel Infill in two versions: **Flexel** (Figure B10b) and **Flexel Light** (Figure B10c). The first is black and is made of foamed rubber, while the Flexel Light is made of a lighter, gray PU foam. Please note: not all sizes are available in both versions.

B11. Flexel PROFILE



B11a. Flexel Profile



B11b. Profile section

The **Flexel Profile** is fitted between tyre and tube, and creates a 100% puncture-proof protection. The Flexel profile can also be used on not-split rims and is also suggested for patients that prefer the pneumatical tyres driving comfort, but would like to avoid punctures.

B12. Fitting tools and accessories

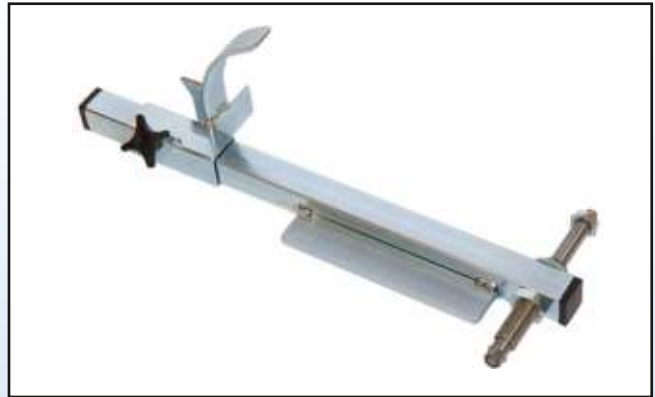

B12a. Mounting tool for polyurethane tyres



B12a. Tyre lever of steel, plastic (black) or from Schwalbe (blue)



B12c. Fitting paste for tyres



B12d. Soap for Flexel fitting



B12e. Sealer for tyres



B12f. Schwalbe glueless patches



B12g. Tube repair set

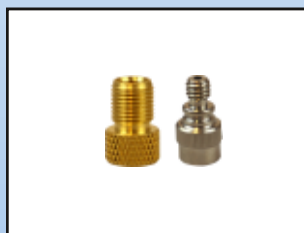

B12h. Valve adapter DV/SV to AV (left), AV to DV/SV (right)



B12i. Schwalbe AirMax digital manometer

Mobilex A/S - Price list

All prices are per pcs. and in EUR.

07.2022

Leaflet B

Standard Tyres (Colours = cap of tyre/lateral)

Item nr.	Description	Foto	Price
205051	5" x 1" Tyre racing profile, IA-2613	B5A	15,00 €
205061	6" x 1 1/4" tyre, 150 x 30 mm, grooved lengthwise, IA-2802	B5B	9,50 €
205071	7" x 1 3/4 Tyre, 175 x 45 mm, grooved lengthwise, IA-2801/C-179	B5B	13,00 €
205081	8" x 1 1/4" Tyre, 200 x 30 mm, grooved lengthwise, IA-2802	B5B	10,50 €
205082	8" x 2" Tyre, 200 x 50 mm, grooved lengthwise, IA-2802	B5B	15,00 €
205085	8" x 2" Tyre, 200 x 50 mm, black, grooved lengthwise, C-179	B5B	16,00 €
205084	8" x 2" Tyre, 200 x 50, block patterned, C-968	B5C	19,00 €
205101	10" x 2" Tyre, 250 x 50, grooved lengthwise, C-179	B5B	18,00 €
205121	12 1/2" x 2 1/4" Tyre, (57-203), light patterned, IA-2601	B5D	18,00 €
205122	12 1/2" x 2 1/4" Tyre, (57-203) block patterned, IA-2814	B5E	20,00 €
205124	12 1/2" x 2 1/4" Tyre, (57-203), black, block patterned, IA-2814	B5E	17,00 €
205126	12 1/2" x 2 1/4" Tyre, (62-203), block patterned, C-628, reinforced	B5E	22,50 €
205129	12 1/2" x 1.75 x 2 1/4" (47-203), tyre, C-607	B5D	14,00 €
205161	16" x 1.75" Tyre (47-305), light patterned, IA-1601	B5D	15,00 €
205205	20" x 1" (25-451) tyre, fishbone, IA-2806	B1A	18,00 €
205201	20" x 1 3/8" Tyre (37-451) light patterned, IA-2205	B1D	15,00 €
205206	20" x 1.75" x 2" (47-406), light patterned, C-97	B5T	17,00 €
205203	20" x 1.75" x 2" (47-406) tyre, black, light patterned, C-97	B5T	32,00 €
205225	22" x 1" (25-498), tyre, fishbone, IA-2806	B1A	18,00 €
205221	22" x 1" tyre (25-489), fishbone, IA-2806	B1A	18,00 €
205228	22" x 1" (25-489) tyre, patterned, IA-2818	B1C	17,00 €
205349	22" x 1" (25-489) VN Master Alpha Protect tyre with puncture protection, black	B4	35,00 €
205223	22" x 1 3/8" (37-489) tyre, light patterned, IA-2205	B1D	16,00 €
205224	22" x 1 3/8" (37-501) Tyre, light patterned, IA-2205	B1D	15,00 €
205222	22" x 1 3/8" (37-498) tyre, light patterned, IA-2205	B1D	16,00 €
205241	24" x 1" (25-540) tyre, fishbone, IA-2806/C-1051	B1A	17,00 €
20534A	24" x 1" (25-540) tyre, nutpatterned, IA-2818	B1C	19,00 €
20534B	24" x 1" (25-540) black Speedlite tyre	B1A	26,50 €
205347	24" x 1" (25-540) VN Master Alpha Protect tyre, black	B4	30,00 €
205246	24" x 1" (25-540) tyre grey/black, fishbone, IA-2806	B1A	19,00 €
205248	24" x 1" (25-541) tyre, black/grey, nutpatterned, IA-2818	B1C	19,00 €
205242	24" x 1 3/8" (37-540) tyre, light patterned, IA-2205	B1D	15,00 €
205243	24" x 1 3/8" (37-540) tyre, patterned, IA-2803	B1E	15,00 €
205249	24" x 1 3/8" (37-540) tyre, grooved lengthwise, C-746	B5B	18,00 €
205244	24" x 1 3/8" x 1 1/4", (32-540) tyre, fishbone, IA-2807	B1B	17,00 €
205345	24" x 1 3/8" (37-540) tyre, knobby patterned, PRIMO KNOBBY	B7F	43,50 €
20524J	24" x 1.75" (47-507), MTB tyre, black	B7A	19,00 €
20534F	MTB tyre 24" x 1.95" (50-507) C-1027 (for Fat Wheel)	B7D	26,50 €
20525V	25" x 1" (25-559) VN Master Alpha Protect tyre, black	B4	31,25 €
20526V	26" x 1" (25-590) VN Master Alpha Protect tyre, black	B4	32,50 €
205262	26" x 1" (25-590) tyre, fishbone, IA-2806	B1A	22,50 €
205261	26" x 1 3/8" (37-590) tyre, light patterned, IA-2205	B1D	16,00 €

Tufo tubolar tyres

Item nr.	Description	Foto	Price
205229	22" x 1" (25-489) Tufo B3, tubular tyres, orange	B3A	81,00 €
20524B	24" x 1" (25-540) Tufo B3, tubular tyres, orange	B3A	83,00 €
20524R	24" x 1" (22-540) Tufo MS3, tubular tyres, blue	B3B	83,00 €
205255	25" x 1" (22-559) Tufo MS3, tubular tyres, blue	B3B	84,00 €
205265	26" x 1" (22-590) Tufo MS3, tubular tyres, blue	B3B	84,00 €
205284	28" x 1" (22-622) Tufo MS3, tubular tyres, blue	B3B	84,00 €

Mobilex A/S - Price list

All prices are per pcs. and in EUR.

07.2022

Leaflet B

Schwalbe tyres (Colours = cap of tyre/lateral)

Item nr.	Description	Foto	Price
205212	12" x 1.75" (47-203), Schwalbe Kid Plus PunctureGuard, black	B6K	16,00 €
20522G	22" x 1" (25-489) Schwalbe Marathon Evolution Reflex tyre, black	B6A	60,00 €
20522D	22" x 1" (25-489) tyre, Schwalbe Rightrun, grey/black	B6C	20,00 €
20522E	22" x 1" (25-501) tyre, Schwalbe Rightrun, grey/black	B6C	18,00 €
20524H	24" x 1 3/8" (37-540) Schwalbe Marathon Plus tyre, grey/black	B6A	53,00 €
205245	24" x 1" (25-540) Schwalbe tyre, 10 bar, fishbone	B1A	18,00 €
20524F	24" x 1" (25-540) Schwalbe tyre, grey/black, 10 bar, fishbone	B1A	18,00 €
20524Z	24" x 1" (25-540) Schwalbe Downtown tyre, grey/black, 10 bar	B6B	20,00 €
20534D	24" x 1" (25-540) Schwalbe Downtown tyre, black, 10 bar, lightpatterned	B6B	22,50 €
20524Y	24" x 1" (25-540) Schwalbe Marathon Evolution tyre, black, 10 bar	B6A	55,00 €
20524A	24" x 1" (25-540) Schwalbe Marathon Evolution Reflex tyre, black, 10 bar	B6A	60,00 €
20524I	24" x 1 1/8" (28-540) Schwalbe Marathon Evolution tyre, black, 10 bar	B6A	55,00 €
20524G	24" x 1" (25-540) Schwalbe Marathon Plus tyre, grey/black, 10 bar	B6A	53,00 €
205343	24" x 1" (25-540) Schwalbe Rightrun tyre, black	B6C	22,50 €
20524T	24" x 1" (25-540) tyre, Schwalbe Rightrun, blue/black	B6C	20,00 €
20524L	24" x 1" (25-540) Schwalbe Rightrun tyre, grey/black	B6C	20,00 €
20524X	24" x 1" (25-540) Schwalbe Rightrun tyre, red/black	B6C	20,00 €
20524U	24" x 1" (25-540) Schwalbe Rightrun Plus tyre, grey/black	B6C	53,00 €
205240	24" x 1 1/8" (28-540) Schwalbe Rightrun tyre, grey/black	B6C	20,00 €
20524K	24" x 3/4" (20-540) tyre, Schwalbe Speed Air, white/black	B6G	60,00 €
20524W	24" x 1" (25-540) tyre, Schwalbe One, black, foldable	B6D	77,00 €
20524S	24" x 1.75" (47-507) Schwalbe Landcruiser, black	B6I	20,00 €
205342	24" x 1 3/8" (37-540) Schwalbe Marathon Evolution tyre, black, 6 bar	B6A	53,00 €
205346	24" x 1 3/8" (37-540) Schwalbe Downtown tyre, grey/black	B6B	22,50 €
205348	24" x 2.10" (54-507) Schwalbe Black Jack	B7B	24,00 €
205253	25" x 1" (25-559) Schwalbe Marathon EvolutionTyre, black, 10 bar	B6A	55,00 €
205252	25" x 1 1/8" (28-559) Schwalbe Marathon Evolution, black, 10 bar	B6A	58,00 €
205254	25" x 1" (23-559) Schwalbe Rightrun tyre, grey/black	B6C	21,50 €
205256	25" x 1 1/8" (28-559) Tyre, Rightrun, grey/black	B6C	21,50 €
20525A	25" x 1" (25-559) Schwalbe One tyre, foldable, black	B6D	83,00 €
205259	25" x 3/4" (20-559) Schwalbe Speed Air tyre, white/black	B6G	55,00 €
205268	26" x 3/4" (20-590) Schwalbe Speed Air tyre, white/black	B6G	55,00 €
205266	26" x 1" (25-590) Schwalbe Marathon Evolution tyre, black, 10 bar	B6A	58,00 €
205263	26" x 1" (25-590) Schwalbe Rightrun tyre, grey/black	B6C	27,50 €
20526C	26" x 1" (23-571) Schwalbe One tyre, foldable, black	B6D	85,00 €
20526B	26" x 1.75" (47-559) Marathon Plus Tour tyre, black	B6J	65,00 €
20526D	26" x 2" (50-559) Schwalbe Black Jack tyre, black	B7B	23,50 €
205282	28" x 1" (23-622) Schwalbe Durano RaceGuard tyre, black	B6E	47,00 €
205281	28" x 1" (23-622) Schwalbe Lugano tyre, black	B6F	20,00 €
205283	28" x 1" (23-622) Schwalbe Speedair tyre, white/black	B6G	55,00 €
260017	Schwalbe Airmax Pro manometer	B12I	23,50 €
210003	Set of 3 pcs. Schwalbe plastic tyre levers	B12J	5,25 €

Kenda tyres with Kevlar insert (Colours = cap of tyre/lateral)

Item nr.	Description	Foto	Price
20524E	24" x 1" (23-540) Kenda K191 Konzept tyre, blue/black	B2A	36,00 €
20524V	24" x 1" (23-540) Kenda K191 Konzept tyre, red/black	B2A	36,00 €
20524N	24" x 1" (23-540) Kenda K191 Konzept tyre grey/black	B2A	36,00 €
205240	24" x 1" (25-540) Kenda Kwick-Trax K1053 tyre, black	B2A	36,00 €
205247	24" x 1" (25-540) Kenda tyre Kwick-Trax grey/black - K1053	B2C	31,00 €
20524M	24" x 1" (25-540) Kenda K196 Kontender tyre, black	B2B	36,00 €
205257	25" x 1" (23-559) Kenda K191 Konzept tyre, red/black	B2A	38,50 €
205258	25" x 1" (23-559) Kenda K191 Konzept tyre, grey/black	B2A	38,50 €
20525E	25" x 1" (23-559) Kenda K-191 Konzept tyre, blue/black	B2A	38,50 €
20525C	25" x 1" (25-559) Kenda K196 Kontender tyre, red/black	B2B	38,50 €
205269	26" x 1" (23-590) Kenda K196 Kontender tyre, red/black	B2B	38,50 €
20526A	26" x 1" (23-590) Kenda K196 Kontender tyre, grey/black	B2B	38,50 €
20526E	26" x 1" (23-590) Kenda K-196 Kontender tyre, blue/black	B2B	38,50 €
205285	28" x 1" (23-622) Kenda K196 Kontender tyre red/black	B2B	38,50 €

Kenda Offroad tyres

Item nr.	Description	Foto	Price
20532W	Kenda Nevegal tyre 22" x 1,95" (50-501), black	B7E	60,00 €
20534W	Kenda Nevegal tyre 24" x 2.1" (54-540) black	B7E	60,00 €

Polyurethan tyres

Item nr.	Description	Foto	Price
211121	12 1/2" x 2 1/4 Polyurethan, grooved lengthwise, C-1009	B5B	34,00 €
211162	16" x 1 3/4" Polyurethane Blockpatterned, Tornado	B1E	66,00 €
211204	20" x 1 3/8" (37-451) polyurethane tyre, blockpatterned, C-2803	B8E	23,50 €
211201	20" x 1 3/8" polyurethane tyre patterned - C1001	B8C	22,50 €
211203	20" x 1" (25-451) polyurethane tyre, fishbone - C-1006	B8C	24,50 €
211221	22" x 1 3/8" (37-489) Polyurethane patterned, C-1001	B8C	23,50 €
211228	22" x 1 3/8" (37-489), polyurethane tyre, blockpatterned, C-2803	B8E	25,50 €
211226	22" x 1 3/8" (37-498/501) polyurethane tyre, block patterned, C-2803	B8E	23,50 €
211222	22" x 1 3/8" (37-498/501) polyurethane tyre, patterned, C-2205	B8D	23,50 €
211229	22" x 1 3/8" (37-498/501), polyurethane tyre, patterned, C-1001	B8C	26,50 €
211225	22" x 1" (14-489) polyurethane tyre, patterned, C-1001	B8C	25,50 €
21122B	22" x 1" (25-489) polyurethane tyre, black patterned, Krypton	B8A	27,50 €
21124H	24" x 1 3/8" (37-540) polyurethane tyre, black block patterned	B8E	27,50 €
211244	24" x 1 3/8" (37-540) polyurethane tyre, block patterned, C-2803	B8E	23,50 €
21124Y	24" x 1 3/8" (37-540) polyurethane tyre, light patterned, box with 30 pcs.	B8C	383,00 €
211242	24" x 1 3/8" (37-540) polyurethane tyre, light patterned, C-1001	B8C	25,50 €
211241	24" x 1 3/8" (37-540) polyurethane tyre, light patterned, C-2205	B8D	24,50 €
21124X	24" x 1 3/8" (37-540), Polyurethane blockpatterned - box with 30 pcs	B8E	383,00 €
21124D	24" x 1" (25-540) polyurethane tyre, block patterned, C-2803	B8E	22,50 €
211243	24" x 1" (25-540) polyurethane tyre, light patterned, C-1001	B8C	22,50 €
21124E	24" x 1" (25-540), polyurethane tyre for narrow rim width, light pattered, black	B8A	30,00 €
21124S	24" x 1" (25-540), polyurethane tyre for narrow rim, light pattered	B8A	30,00 €
21124Z	24" x 1" (25-540), polyurethane tyre, light patterned, box with 30 pcs.	B8A	383,00 €
211248	24" x 1" Polyurethane, black, patterned	B8C	23,50 €
211252	25" x 1" (23-559) Polyurethane, black, patterned	B8A	25,50 €
211251	25" x 1" (23-559), polyurethane tyre, light patterned C-1001,	B8C	23,50 €
211261	26" x 1 3/8" (37-590) polyurethane tyre, light patterned, C-2205	B8D	27,50 €
211262	26" x 1" (25-590) polyurethane tyre, light patterned, C-1001	B8C	27,50 €
211263	26" x 1" (25-590) Polyurethane, fishbone, black, patterned	B8B	27,50 €

All PU covers are grey and for standard rim widths, unless otherwise stated.

Fitting tools

Item nr.	Description	Foto	Price
210001	Tyre lever of steel	B12B	25,50 €
210002	Tyre lever of plastic (3 pcs).	B12B	5,25 €
210005	Cone key for car valve type	B12K	9,50 €
210008	Lubricant for montage of tyres, 1 kg	B12C	38,50 €
210010	Liquid for Flexel fitting, 1/2 litre	B12D	17,00 €
210011	Tyre sealer, 1litre	B12E	31,00 €
210012	Patch adhesive (vulcaniser liquid), 25g/35ml	B12L	9,50 €
210023	Schwalbe glueless patches (package with 6 pieces)	B12F	8,50 €
210021	Tube-Repair-Set with patches	B12G	4,25 €
210020	Tube patch F1, ø25 mm, package with 100 pc		48,00 €
210090	Pump nippel car -> bike valve	B12HB	4,25 €
210091	Pumpniple bike -> car valve	B12HA	2,25 €
207990	Valvecone, short for straight car valve	B12M	1,50 €
211501	Mobilex PU-fitting device	B12A	173,00 €

Tyres for e-wheelchairs

Item nr.	Description	Foto	Price
206031	2.50" - 3" (210x65) tyre, grooved lengthwise, IA-2802	B5B	21,50 €
206033	2.50" - 3" (210x65) tyre, blockpatterned, C-248	B5I	30,00 €
206034	2.50" - 3" (210x65) tyre, black, grooved, C-179	B5B	20,00 €
206041	2.80" - 2.5" - 4" tyre, lighth patterned, IA-2817	B5H	21,50 €
20604L	2.80" - 2.50" - 4" tyre, light patterned, C-178	B5G	23,50 €
20604A	2.80" - 2.50" - 4" tyre, grooved lengthwise, C-179	B5B	22,50 €
20604K	2.80" - 2.50" - 4" tyre, black, light patterned, C-178	B5G	21,50 €
206042	3.00" - 4" (260x85) tyre, block patterned, IA-2805	B5I	25,50 €
206043	3.00" - 4" (260x85) tyre, grooved lengthwise, IA-2802	B5B	25,50 €
206044	3.00" - 4" (260x85) tyre, V-profile, IA-2804	B5L	25,50 €
206049	3.00" - 4" (260x85) tyre, V-profile, C-920	B5F	47,00 €
20604E	3.00" - 4" (260x85) tyre, black, V-profile, C-920	B5F	46,00 €
20604D	3.00" - 4" (260x85) tyre, block patterned, C-248	B5I	25,50 €
20604F	3.00" - 4" (260x85) tyre, black, block patterned, C-248	B5I	27,50 €
206045	4.10" - 3.50" - 4" tyre, light patterned, C-189	B5F	29,00 €
20604B	4.00" - 4" tyre, block patterned, C-248	B5I	30,00 €
206048	4.00" - 4" Tyre, black patterned HF 210	B5K	38,50 €
20605A	3.00" - 5" tyre, V-profile, C-920	B5F	51,00 €
206053	4.00" - 5" tyre, block patterned, IA-2815	B5J	40,50 €
206056	4.00" - 5" tyre, block patterned, C-154	B5J	48,00 €
206055	4.00" - 5" tyre, block patterned, black, C-154	B5J	48,00 €
206054	4.10" - 3.50" - 5" tyre, block patterned, C-156	B5K	35,00 €
206057	4.10" - 3.50" - 5" tyre, block patterned, C-154	B5J	37,50 €
206058	4.10" - 3.50" - 5" Tyre, block patterned, C-154, black	B5J	36,00 €
20606C	2.50" - 6" tyre, light patterned, C-177	B5Q	36,00 €
206065	3.00" - 6" tyre, V-profil, C-917	B5M	44,50 €
20606D	4.00-6 tyre black block pattern C-166	B5K	47,00 €
206068	4.10" - 3.50" - 6" tyre, black, profile C-178	B5G	42,50 €
206062	4.10" - 3.50" - 6" tyre, black, block patterned, C-156	B5K	41,50 €
206063	4.10" - 3.50" - 6" tyre, 4 layer, block patterned, C-168	B5O	37,50 €
206066	4.10 - "3.50" - 6" tyre, 6 layers, block patterned, C-156/ IA 2805	B5K	38,50 €
20606A	4.10" - 3.50" - 6" tyre, black, block patterned, C-168	B5O	41,50 €
206069	5.30" - 4.50" - 6" tyre, 6 layers, block patterned, C-166	B5P	60,00 €
20608D	2.50" - 8" tyre, light patterned, IA-2817	B5H	31,00 €
20608A	2.50" - 8" tyre, light patterned, C-177	B5Q	40,50 €
20608B	2.50" - 8" tyre, black, block patterned, C-177	B5Q	47,00 €
206081	3.00" - 8" tyre, block patterned, IA-2805	B5I	36,00 €
206088	3.00" - 8" Tyre, block patterned, IA-2805, reinforced	B5I	42,50 €
206082	3.00" - 8" tyre, grooved lengthwise, C-179	B5B	46,00 €
206083	3.00" - 8" tyre, V-profile, IA-2804	B5L	36,00 €
206085	3.00" - 8" tyre, black, block patterned, IA-2805	B5R	36,00 €
206087	3.00" - 8" tyre, block patterned, C-248	B5I	44,50 €
20608L	3.00" - 8" Tyre, V-profile, C-917	B5M	52,00 €
20608K	3.00" - 8" Decke, black, Racing profile, C-917	B5M	55,00 €
20608M	3.00" - 8" Tyre (3.00-90-8), black, IA-2805, Minicrosser	B5R	34,00 €
206089	3.00" - 8" Tyre, black patterned, C-248	B5R	42,50 €
20608C	3.50" - 8" tyre, block patterned, C-168	B5O	65,00 €
20608E	4.00" - 8" tyre, block patterned, C-168	B5O	68,00 €
206102	3.00" - 10" tyre, block patterned, C-131	B5S	77,00 €
206106	3.00" - 10" Tyre, V profile, C-917	B5M	81,00 €
206133	13" - 5.00" - 6", tyre, block patterned, C-9266/C-165	B5N	54,00 €
206132	13" - 5.00 - 6", Tyre, black, patterned, C-9266/C-165	B5N	51,00 €

Cámaras de aire

Código	Descripción	Venta
207051	Cámara de 5" x 1", 125 x 30, válvula 45/45	9,50 €
207061	Cámara 6" x 1 1/4", 150 x 30, válvula 45/45	7,50 €
207071	Cámara, 7" x 1 3/4", 175 x 45, válvula 90/30	8,50 €
207072	Cámara 7", 175 x 45, válvula 90/90	7,50 €
207081	Cámara 8" x 1 1/4", 200 x 30, válvula 45/45	7,50 €
207082	Cámara 8" x 2", 200 x 50, válvula 90/30	8,50 €
207083	Cámara 8" x 2", 200 x 50, válvula 90/90	8,50 €
207101	Cámara 10" x 2", válvula recta	8,50 €
207121	Cámara 12 1/2" x 2 1/4", válvula recta	5,25 €
207122	Cámara 12 1/2" x 2 1/4", válvula. 90/90	7,50 €
207124	Cámara Schwalbe 12 1/2" x 2 1/4", válvula 45/45	8,50 €
207161	Cámara 16" x 1.75"/2.125", válvula recta	6,50 €
207201	Cámara 20" x 1 3/8", válvula recta	6,50 €
207202	Cámara 20" x 1", válvula recta	6,50 €
207203	Cámara 20" x 1.75"/2.125", válvula recta	8,50 €
207207	Cámara Schwalbe 20" x 1 3/8", válvula recta	9,50 €
207221	Cámara 22" x 1" válvula recta	6,50 €
207222	Cámara 22" x 1 3/8", válvula recta	6,50 €
207223	Cámara, Schwalbe 22" x 1", válvula recta	8,50 €
207225	Cámara Schwalbe 22" x 1 3/8" válvula recta	9,50 €
207241	Cámara 24" x 1 3/8", válvula recta	6,50 €
207242	Cámara 24" x 1" válvula recta	6,50 €
20724A	Cámara 24" x 1", Cheng Shin, válvula recta	8,50 €
207245	Cámara 24 "x 1.75" (47-507), válvula recta	6,50 €
207246	Cámara Schwalbe 24" x 3/4" - 24" x 1" (20/28-540), válvula recta	9,50 €
207247	Cámara Schwalbe 24" x 1 3/8", 28/47-507/541, válvula recta	9,50 €
207249	Cámara Schwalbe, 24" x 3/4", 24" x 1" (20/28-540), válvula Presta 40 mm	9,50 €
20724W	Cámara 24" x 1,95"/2,125", válvula recta	17,00 €
207251	Cámara 25" x 1", válvula recta	6,50 €
207252	Cámara Schwalbe 25" x 1" (25-559), válvula recta	8,50 €
207253	Cámara, Schwalbe 25" x 3/4" (20-559) válvula recta	8,50 €
207254	Cámara Schwalbe 25" x 3/4" (18/25-559/571), válvula Presta	9,50 €
207261	Cámara 26" x 1 3/8" válvula recta	6,50 €
207262	Cámara 26" x 1" válvula recta	6,50 €
207264	Camara Schwalbe 26" x 1" (20-590) válvula recta	9,50 €
207265	Cámara Schwalbe 26" x 1 3/4" (47-559), válvula recta	9,50 €
207267	Cámara Schwalbe 26" x 3/4" (20-590), válvula Presta	9,50 €
207281	Cámara 28" x 1" (19/23-622), válvula Presta 48 mm	7,50 €
207282	Cámara Schwalbe 28" x 1" (18/28-622), válvula Presta	9,50 €
207283	Cámara Schwalbe 28" x 7/8" (23-622), válvula recta	9,50 €

Cámaras de aire para silla de ruedas electrónicas

Código	Descripción	Venta
208031	Cámara 2.50" - 3", válvula 90/90	10,50 €
208041	Cámara 2.80" - 2.50" - 4" válvula 90/90	11,50 €
208042	Cámara 3.00" - 4", válvula 90/90	11,50 €
208043	Cámara 4.00" - 4" / 4.10 / 3.50" - 4", válvula 90/90	11,50 €
208051	Cámara 3.50" / 4" - 4", válvula 90/90	11,50 €
208054	Cámara 3.00" - 5", válvula 90/90	13,00 €
208052	Cámara 4.00" - 5" / 4.10 - 3.50" - 5", válvula 90/90	15,00 €
208061	Cámara 4.10" - 3.50" - 6", válvula 90/90	15,00 €
208062	Cámara 4.10" - 3.50" - 6", válvula recta	13,00 €
208064	Cámara 5.30" - 4.50" - 6", válvula 90/90	19,00 €
208066	Cámara 2.50" - 6", válvula 90/90	10,50 €
208065	Cámara 3.00" - 6", válvula 90/90	14,00 €
208081	Cámara, 3.00" - 8", válvula 90/90	13,00 €
208082	Cámara 3.00" - 8", válvula recta	11,50 €
208083	Cámara 2.50" - 8", válvula 90/90	11,50 €
208084	Cámara 3.50" - 8" / 4.00" - 8", válvula recta	14,00 €
208085	Cámara 3.50" - 8" / 4.00 - 8", válvula 90/90	15,00 €
208102	Cámara 3.00" - 10" / 3.00" - 3.50" - 10", válvula 90/90	18,00 €
208131	Cámara 13 - 5.00 - 6", válvula 90/90	17,00 €

Flexel Insert

Item nr.	Description	Foto	Price
212121	12 1/2" x 2 1/4" Flexel Insert for non split rims - with lip	B9A	64,00 €
212122	12 1/2" x 2 1/4" Flexel Insert for split rims - without lip	B9B	64,00 €
212241	24" x 1" Flexel Insert SD, width 20 mm	B9A	30,00 €
212245	24" x 1" Flexel Insert, width 25 mm	B9A	32,00 €
212242	24" x 1 3/8" Flexel Insert	B9A	36,00 €
212243	24" x 1" Flexel Insert without lip	B9B	40,50 €
212244	24" x 1 3/8" Flexel Insert without lip	B9B	50,00 €

Flexel Infill

Item nr.	Description	Foto	Price
213071	Flexel Infill 7" x 1 3/4", grooved lengthwise, width 32 mm	B5B	26,50 €
213081	Flexel Light Infill 8" x 2" (200 x 50), grooved lengthwise, IA--2802, width 32 mm	B5B	30,00 €
213086	Flexel Infill 8" x 2", grooved lengthwise C-179, black, width 32 mm	B5B	52,00 €
21308A	Flexel Infill 8" x 2" (200 x 50), blockpatterned IA-2622, width 32 mm	B5C	36,00 €
21308L	Flexel Infill 8" x 2", grooved, C-179, width 42 mm	B5B	38,50 €
21308G	Flexel Infill 8" x 2", blockpatterned C-968, width 36 mm for Vermeiren Drive	B5C	38,50 €
21308F	Flexel Infill 8" x 2", blockpatterned C-968, width 42 mm for Vermeiren Drive	B5C	38,50 €
213089	Flexel Infill 8 1/2" x 2", light patterned, IA-2817, width 36 mm	B5H	38,50 €
213031	Flexel Light Infill 2.50" - 3", grooved IA-2802, width 42 mm	B5B	44,50 €
213032	Flexel infill 2.50" - 3", grooved lengthwise, black, C-179, width 42 mm	B5B	49,00 €
213036	Flexel infill 2.50" - 3", black blockpatterned, width 42 mm, C-248	B5I	55,00 €
213034	Flexel Infill 2.50" - 3", blockpatterned C-248, width 42 mm	B5I	54,00 €
213035	Flexel Infill 2.50" - 3", grooved, Impac IS-300, width 42 mm	B5B	51,00 €
21304E	Flexel Infill 2.80"/2.50 - 4", grooved C-179, width 48 mm	B5B	51,00 €
213041	Flexel Light Infill 2.80"/2.50 - 4", light patterned IA-2817, width 58 mm	B5H	41,50 €
21304H	Flexel infill 2.80"/2.50 - 4", light patterned, C-178 black, width 58 mm	B5G	51,00 €
213042	Flexel Infill 2.80"/2.50 - 4", light patterned IA-2817, width 72 mm	B5H	51,00 €
213043	Flexel Light Infill 3.00" - 4", block patterned IA-2805, width 72 mm	B5I	63,00 €
213044	Flexel Infill 3.00" - 4", grooved lengthwise, width 72 mm	B5B	77,00 €
213045	Flexel Infill 2.80"/2.50 - 4", grooved lengthwise C-179, width 63 mm	B5B	51,00 €
213046	Flexel Infill 3.00" - 4", V profile C-920, width 58 mm	B5F	92,00 €
213048	Flexel Infill 4.00" - 4", block patterned C-248, width 63 mm	B5I	102,00 €
213049	Flexel Infill 3.00" - 4", block patterned IA-2805 / C-248, width 58 mm	B5I	77,00 €
21304A	Flexel Infill 3.00" - 4", V-profile IA-2804, width 63 mm	B5M	77,00 €
21304B	Flexel infill 3.00" - 4", blockpatterned, black, C-248, flexelwidth 58 mm	B5I	77,00 €
21304C	Flexel Infill 3.00" - 4", block patterned C-248, width 65 mm	B5I	77,00 €
21304D	Flexel Infill 3.00" - 4", V-profile C-920, width 68 mm	B5F	93,00 €
213051	Flexel Infill 4.00" - 5", block patterned IA-2815, width 68 mm	B5J	107,00 €
213052	Flexel Infill 4.10" - 3.5" - 5", block patterned C-156, width 68 mm	B5K	92,00 €
213063	Flexel infill 4.10" - 3.50" - 6", black, block patterned, C-156, width 60 mm	B5K	118,00 €
213062	Flexel Infill 4.10" - 3.50" - 6", block patterned, C-156, width 67 mm	B5K	118,00 €
213069	Flexel infill 4.10" - 3.50" - 6", black, block patterned, C-156, width 67 mm	B5K	118,00 €
213065	Flexel Infill 3.00" - 6", V-profile C-917, width 51 mm	B5M	72,00 €
213066	Flexel Infill 13" - 5.00" - 6", block patterned C-165, width 68 mm	B5N	199,00 €
213067	Flexel infill 13" - 5.00" - 6", black, block patterned C-165, width 68 mm	B5N	199,00 €
213082	Flexel Light Infill 3.00" - 8", block patterned IA-2805, width 53 mm	B5I	79,00 €
213083	Flexel Light Infill 3.00" - 8", block patterned IA-2805, width 38 mm	B5I	79,00 €
21308C	Flexel Infill 3.00" - 8", V-profile C-917, width 38 mm, C-917	B5M	97,00 €
213084	Flexel Infill 3.00" - 8", V-profile C-917, width 48 mm	B5M	109,00 €
213085	Flexel Infill 3.00" - 8", V profile, IA-2804, width 53 mm	B5M	102,00 €
21308S	Flexel infill 3.00" - 8", black, blockpatterned IA-2805, width 48 mm	B5R	100,00 €
213087	Flexel infill 3.00" - 8", black, blockpatterned IA-2805, width 53 mm	B5I	109,00 €
21308B	Flexel Infill 2.50" - 8", light patterned IA-2817, width 48 mm	B5H	79,00 €
21308D	Flexel Infill 3.50" - 8", block patterned, C-168, width 38 mm	B5O	143,00 €
21308E	Flexel Light Infill 3.00" - 8", block patterned IA-2805, width 48 mm	B5I	85,00 €
21308J	Flexel Infill 3.00" - 8", V-profile C-917, width 58 mm	B5M	109,00 €
21308M	Flexel infill 3.00/90" - 8", black, block C-248/IA-2805, width 65 mm for Minicrosser	B5R	72,00 €
213103	Flexel Infill 3.00" - 10", block patterned, C-131, width 58 mm	B5S	134,00 €

Flexel profile

Item nr.	Description	Foto	Price
214041	Flexel profile insert 3.00" - 4"	B11A	23,50 €
214061	Flexel profile insert 4.10" - 3.50" - 6" / 4.00" - 5"	B11A	27,50 €
214081	Flexel profile insert 3.00" - 8"	B11A	30,00 €
214131	Flexel profile insert 13" - 5.00" - 6"	B11	30,00 €

The following is an explanation of the tyre sizes. On the next pages you will also find a matrix showing the right Flexel Infill for the most commonly used electrical wheelchairs.

Table of standard Flexel Infill tyres (for prices please see above)

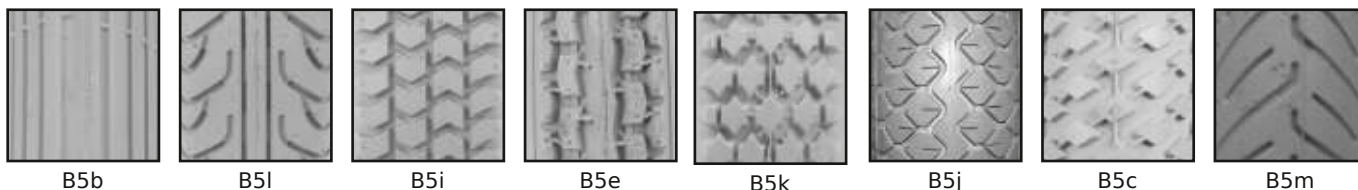

Size	Colour	Profile	Pic.	Width - item nr.	Type	Width - item nr.	Type	Width - item nr.	Type
7 x 1 3/4	grey	Grooved	B5d	33 mm - 213071	F				
200 x 50	grey	Grooved	B5d	33 mm - 213081	FL				
200 x 50	grey	block	B5c	33 mm - 21308A	F				
2.50 x 3	grey	Grooved	B5d	43 mm - 213031	FL				
2.50 x 3	grey	block	B1g	43 mm - 213034	F				
2.50 x 3	black	Grooved	(B5d)	43 mm - 213032	F				
2.80 - 2.50 x 4	grey	Patterned	B5e	58 mm - 213041	FL	72 mm - 213042	F		
2.80 - 2.50 x 4	grey	Grooved	B5d	63 mm - 213045	F				
3.00 - 4	grey	block	B1g	58 mm - 213049	F	72 mm - 213043	FL		
3.00 - 4	grey	V-Profil	B5m	58 mm - 213046	F				
3.00 - 4	grey	Grooved	B5d	72 mm - 213044	F				
3.00 - 4	black	block	(B1g)	58 mm - 21304B	F				
4.00 - 4	grey	block	B1g	63 mm - 213048	F				
4.00 - 5	grey	Patterned	B5j	68 mm - 213051	F				
4.10 - 3.50 x 5	grey	block	B5k	68 mm - 213052	F				
3.00 - 6	grey	V-Profil	B5m	51 mm - 213065	F				
2.50 - 8	grey	Patterned	B5h	48 mm - 21308B	F				
3.00 - 8	grey	block	B5i	36 mm - 213083	FL	48 mm - 21308E	FL	53 mm - 213082	FL
3.00 - 8	grey	block	B5i	36 mm - 213...	F	48 mm - 213...	F	53 mm - 213...	F
3.00 - 8	black	block	(B5i)	53 mm - 213087	F				
3.00 - 8	grey	Patterned	B5l	53 mm - 213085	F				
3.00 - 10	grey	block	B5i	58 mm - 2130103	F				

* Type: F=Flexel, FL=Flexel light

Attention: We supply the Flexel insert in two versions: Flexel and Flexel Light.

"Flexel" is black and made of foam rubber, while "Flexel Light" is made of grey polyurethane foam.

Not all tyre sizes are available in both versions.

Tyre sizes, inch and metric tyre names and markings

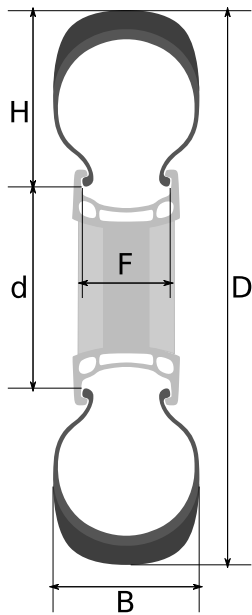

a) Tyre dimensions for scooters or e-wheelchairs,
Rear or front wheels

D = tyre outside diameter

d = rim diameter

H = balloon height

B = balloon width

Only for Flexel:

F = rim shoulder width inside

Examples:

13 / 5.00 - 6 D = 13 ", B = 5.00", d = 6 "

3.00-4, both H and B = 3.00 ", d = 4"

3.00 / 90-8 H = 3.00 ", B corresponds to 90% of H, d = 8"

b) Tyre dimensions for large rear wheels of hand-operated wheelchairs

(Using the example of a 24 "x 1" wheel)

ISO (ETRTO)	English (inch)	French (mm)
25 - 540 Width - inner Ø (mm)	24" x 1" Outer Ø - width (inch)	600 x 25 Outer Ø - width (mm)

The same tyre can have different measurements! (ETRTO, inch or mm - see pictures)

Tyre table for electronic wheelchairs

Producer	Model	FRONT tyre	Pattern	Mobilex Item nr.
Invacare	Moover 85	12 1/2" x 2 1/4"	Block	212121 + 205126
Invacare	Moover 95	--	--	--
Invacare	Storm 3	3.00" - 6"	Racing	213065
Invacare	Storm X5	3.00" - 4"	Block	213043
Meyra	Champ	2.80" / 2.50" - 4"	Ribbed	213042
Meyra	Optimus	3.00" - 10"	Block	213103
Meyra	Smart	3.00" - 4"	Ribbed	213044
Meyra	Sprint	3.00" - 4"	Ribbed	213044
Otto Bock	B500	2.50/2.80" - 4"	Ribbed	21304E
Permobil	C500	3.00" - 8"	Block	213082
Permobil	Chairman	3.00" - 8"	Block	213082
Sunrise	Quickie P220	--	--	--
Vermeiren	Tracer	3.00" - 4"	Block	213043

Producer	Model	REAR tyre	Pattern	Mobilex Item nr.
Invacare	Moover 85	200 x 50	Ribbed	213081
Invacare	Moover 95	3.00" - 4"	Block	213043
Invacare	Storm 3	8 1/2" x 2"	V-Profile	213082
Invacare	Storm X5	3.00" - 8"	Block	213087
Meyra	Champ	3.00" - 8"	Racing	21308J
Meyra	Optimus	3.00" - 8"	Block	213082
Meyra	Smart	3.00" - 8"	Racing	21308J
Meyra	Sprint	3.50" - 8"	Block	21308D
Otto Bock	B500	3.00" - 8"	Block	21308E
Permobil	C500	2.50" - 3"	Ribbed	213031
Permobil	Chairman	200 x 50	Complete wheel	204086
Sunrise	Quickie P220	4.10" / 3.50" - 6"	Block	213062
Vermeiren	Tracer	3.00" - 8"	Racing	213085

Tyre table for scooters

Producer	Model	FRONT tyre	Pattern	Mobilex Item nr.
Invacare	Auriga	3.00" - 4"	Ribbed	213044
Invacare	Meteor	4.00" - 5"	Block	213051
Ortopedia	Touring 926	3.50" - 10"	Block	213102
Sunrise	Elite	4.10" / 3.50" - 6"	Block	213061
Sunrise	Swift	3.00" - 4"	Ribbed	213044

Producer	Model	REAR tyre	Pattern	Mobilex Item nr.
Invacare	Auriga	3.00" - 4"	Block	213043
Invacare	Meteor	4.00" - 5"	Block	213051
Ortopedia	Touring 926	4.10" / 3.50" - 6"	Block	213062
Sunrise	Elite	13" - 5.00" - 6"	Block	213066
Sunrise	Swift	3.00" - 4"	Block	213043

LARGE WHEELS

LARGE WHEELS



Leaflet C, CX, CY, CZ

Large wheels and accessories, Spinergy, pushrims, one-hand drive and drum brake set

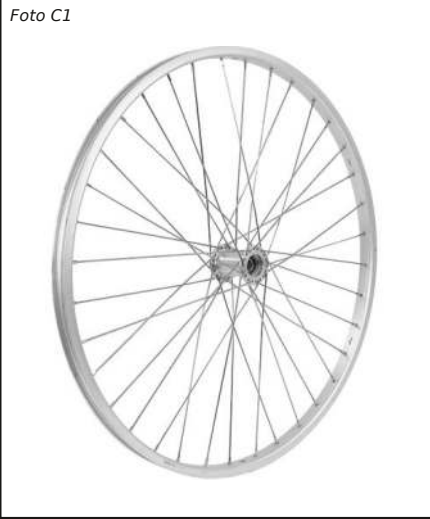

Aluminium standard wheel without tire and pushrim. Available in 20", 22", 24" and 26".

Standard wheel	
Hub width	49 or 53 mm
Bearings	12 mm oder 1/2"
Max. load	75 kg per wheel



Standard wheels with drum brake without tires and pushrim. Available in 20", 22", 24" and 26".

Standard wheel with drum brake	
Hub width	46 mm
Bearings	12 mm
Max. load	75 kg per wheel



Complete wheel from aluminium with black hub, PU tyre and aluminium pushrim. Available in 20", 22" and 24".

Complete wheel	
Hub width	49 mm
Bearings	12 mm oder 1/2"
Max. load	75 kg per wheel

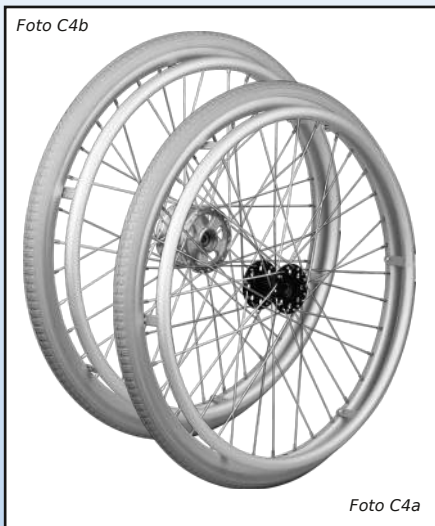

Buffalo HD wheel with reinforced 53 mm hub with 2.6 mm spokes. The black aluminium rim is reinforced and equipped with a built-in pushrim. It has a 1 3/8" tyre with Flexel. Only available in 24".

Buffalo Heavy Duty	
Hub width	53 mm
Bearings	12 mm or 1/2"
Max. load	140 kg per wheel



Complete wheel for Invacare wheelchairs with 1" tyre (C10) or Etac with 1 3/8" tyre (C11). Silver aluminium pushrim. Available in 20", 22" and 24". For Etac also available in 26".

Complete wheel for Handicare	
Hub width	53 mm
Bearings	12 mm
Max. load	75 kg per wheel



The **Ultralite wheel** is an easy and inexpensive wheel with a total weight of only 1120 grams. Comes with double walled black rim, black aluminium hub, aluminium pushrim and 1" tyres. Only available in 24".

Ultralite	
Hub width	49 mm
Bearings	12 mm or 1/2"
Max. load	75 kg per wheel



Mobilex **Storm** wheel with 12 spokes, black hollow rim with 1" Speedline tyre, black CNC machined aluminium hub and black aluminium pushrim. Total weight 1890 grams incl. tyre, tube and pushrim. Only available in 24".

Storm	
Hub width	49 mm
Bearings	12 mm or 1/2"
Max. load	75 kg per wheel



The Tristar wheel is an aluminium wheel with 3 large spokes. The total weight incl. tyre and tube is 1730 grams. The "Black Pearl" colour is black with bright dots.

Tristar	
Hub width	49 mm
Bearings	12 mm or 1/2"
Max. load	75 kg per wheel



Mobilex **Offroad** wheel with black double wall rim mounted on black high flange hub. Black aluminium pushrim, with tube and black 24" offroad tyre. The wheel can be delivered with 12 mm or with 1/2" bearings. Only available in 24".

Mobilex Offroad	
Hub width	53 mm
Bearings	12 mm or 1/2"
Max. load	75 kg per wheel



Mobilex **Offroad Twin** wheel with welded double wall aluminium rim. 2 MTB tyres 1.75" x 24". Black high flange hub with 1/2" bearings. Black aluminium pushrim. Only available in 24".

Mobilex Offroad Twin	
Hub width	mm
Bearings	1/2"
Max. load	75 kg pro Rad



FAT Wheel complete with black aluminium rim and black aluminium hub, 36 galvanized steel spokes and black aluminium pushrim. MTB studded tyres 24" x 1.95". Only available in 24".

FAT Wheel	
Hub width	53 mm
Bearings	12 mm or 1/2"
Max. load	75 kg per wheel



Mobilex **Outdoor Extreme** Wheel with black aluminium rim, black high flange hub, Schwalbe Black Jack tyre 24" x 2.10" (54-507) and black aluminium pushrim. Only available in 24".

Outdoor Extreme	
Hub width	53 mm
Bearings	12 mm or 1/2"
Max. load	75 kg per wheel

Accessories for rear wheels

Quick release axles, bushings, bearings, cables and outer casing

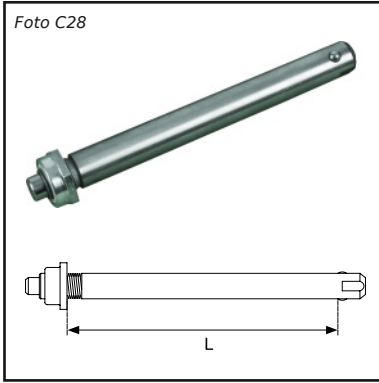

Quick release axle

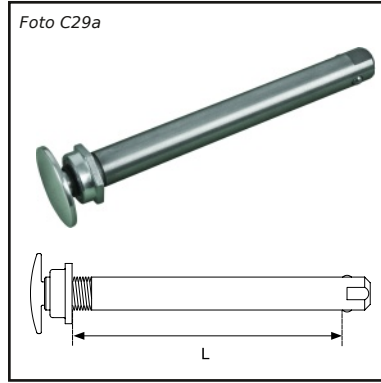

Quick release axle with big button (silver or black coloured)

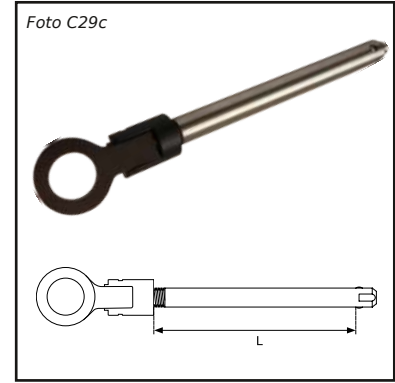

QR axle with Tetragreb

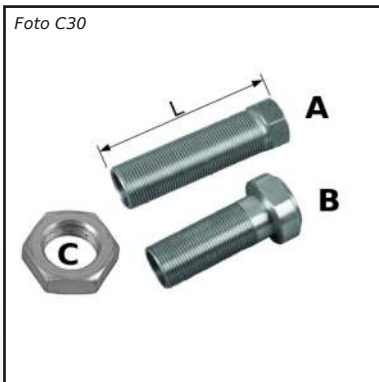

Bushings and screw nut

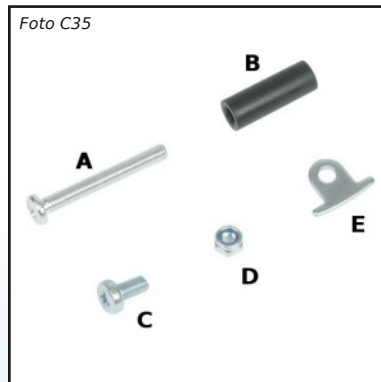

Parts for fitting of pushrims



Reflector

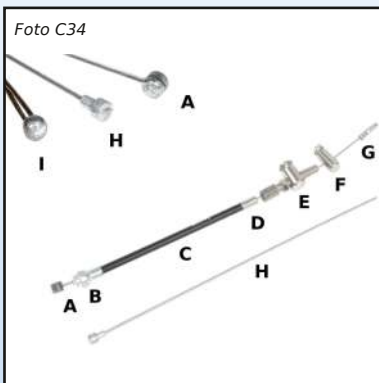

Cable parts



Roll with 50 mt. outer casing, box with 100 cables



Rim tapes



Bearing



Box with 50 pcs. assorted bearings (9 sizes)



Tool for assembling of bearings on rear wheels

Standard rear wheels - without tyre and pushrim

Item nr.	Description	Ø	Foto	Price
D1020	Standard wheel, 20" with 12 mm hub without tyre, tube and pushrim	451	C1	47,00 €
D1022	Standard wheel 22" with 12 mm hub without tyre, tube and pushrim	489	C1	47,00 €
D1024	Standard wheel 24" with 12 mm hub without tyre, tube and pushrim	540	C1	47,00 €
D1026	Standard wheel 26" with 12" hub without tyre/tube and pushrim	590	C1	55,00 €

D1120	standard wheel 20" with 1/2" hob without tyre, tube and pushrim	451	C1	47,00 €
D1122	standard wheel 22" with 1/2" hub without tyre, tube and pushrim	489	C1	47,00 €
D1124	Standard wheel 24" with 1/2" hub without tyre/tube and pushrim	540	C1	47,00 €
D1126	Standard wheel 26" with 1/2" hub without tyre/tube and pushrim	590	C1	55,00 €

215203	20" Drum brake wheel without brakeplate	451	C2	89,00 €
215223	22" Drum brake wheel, 489 mm rim, ø12 mm hub, without brakeplate	489	C2	89,00 €
21522P	22" Drum brake wheel, 501 mm rim, ø12 mm hub, without brakeplate	489	C2	89,00 €
215243	24" Drum brake wheel without brakeplate, 12 mm bearings	540	C2	83,00 €
215263	26" Drum brake wheel without brakeplate, ø12 mm bearings	590	C2	160,00 €

Ultralite rear wheels - without tyre and pushrim

Item nr.	Description	Ø	Price
21820U	20" Ultralite light weight wheel with 12 mm black hub, black rim, without tire, tube and pushrim	451	137,00 €
21822U	22" Ultralite light weight wheel with 12 mm black hub, black rim, without tire, tube and pushrim	489	137,00 €
21834U	24" Ultralite light weight wheel with 12 mm black hub and rim, without tire and pushrim	540	137,00 €
21826U	26" Ultralite light weight wheel with 12 mm black hub, black rim, without tire, tube and pushrim	590	137,00 €

Fitting of pushrims and tyres and exchange of bearings

If wheels are to be delivered completely assembled, we charge the following costs for fitting

Item nr.	Description	Price
D3130	Fitting of pushrim on wheel	21,50 €
D3110	Fitting of tyre and tube on wheel	21,50 €
D3120	Fitting of PU tyres on wheel	21,50 €
D3121	Mounting of Flexel on wheels	32,00 €

Note: You will find pushrims in **Leaflet CY** and tyres in **Leaflet B**

Complete rear wheels

Item nr.	Description	Ø	Foto	Price
21520A	20" wheel, silver ø12 mm hub for Etac, 1 3/8" PU, silver pushrim with 4 holes for clips	451	C11	119,00 €
21522A	22" wheel, silver ø12 mm hub for Etac, 1 3/8" PU, silver pushrim with 4 holes for clips	498	C11	119,00 €
21524D	24" wheel, silver ø12 mm hub for Etac, 1 3/8" PU, silver pushrim with 4 holes for clips	540	C11	119,00 €

21520C	20" wheel, silver, ø12 x 53 mm hub, tyre 1", silver aluminium pushrim	451	C11	134,00 €
21522C	22" wheel, silver, ø12 x 53 mm hub, tyre 1", silver aluminium pushrim	489	C11	134,00 €
21524C	24" wheel, silver, ø12 x 53 mm hub, tyre 1", silver aluminium pushrim	540	C11	134,00 €
21526C	26" wheel, silver, ø12 x 53 mm hub, tyre 1", silver aluminium pushrim	590	C11	143,00 €

21520F	20" wheel, black hub ø12 x 53 mm, PU tyre 1 3/8", silver aluminium pushrim	451	C3	72,00 €
21522F	22" wheel, black, ø12 x 53 mm hub, PU tyre 1 3/8", silver aluminium pushrim	489	C3	77,00 €
21524F	24" wheel, black, ø12 x 53 mm hub, PU tyre 1 3/8", silver aluminium pushrim	540	C3	77,00 €

21520S	20" wheel, black hub ø12 x 53 mm, 1 3/8" PU tyre, 4 hole silver alu. pushrim	451	C10	107,00 €
21522S	22" wheel, black hub ø12 x 53 mm, 1 3/8" PU tyre, 4 hole silver alu. pushrim	489	C10	107,00 €
21524S	24" wheel, black hub ø12 x 53 mm, 1 3/8" PU tyre, 4 hole silver alu. pushrim	540	C10	107,00 €

21520R	20" wheel, black hub ø12 x 53 mm, 1" tyre/tube, 4 hole silver pushrim	451	C10	107,00 €
21522R	22" wheel, black hub ø12 x 53 mm, 1" tyre/tube, 4 hole silver pushrim	489	C10	107,00 €
21524R	24" wheel, black hub ø12 x 53 mm, 1" tyre/tube, 4 hole silver pushrim	540	C10	107,00 €

Special complete rear wheels

Item nr.	Description	Foto	Price
21824L	24" Ultralite wheel, 1/2" hub, black rim, with tyre and silver aluminium pushrim	C5	190,00 €
D1519	24" Ultralite wheel, 1/2" hub, black rim, with tyre and silver aluminium pushrim	C5	190,00 €
218248	24" Storm wheel, black, 12 mm hub, black pushrim, black rim with 1" tyre	C6	190,00 €
D1521	24" Storm wheel, black, 1/2" hub, black pushrim, black rim with 1" tyre	C6	190,00 €
218232	24" Tristar wheel with black pushrim, tyre and tube	C12	445,00 €
218240	Offroad wheel 24" x 1.75 (47-504) MTB tyre, 12 mm hub, black aluminium pushrim	C7	200,00 €
218242	Offroad wheel 24" x 1.75 (47-504) MTB tyre, 1/2" hub, black aluminium pushrim	C7	200,00 €
D1514	Offroad wheel 24" x 1.75" (47-507) MTB tyre, 12 mm bearings, High Friction pushrim	C7	213,00 €
218247	Offroad wheel 24" x 1.75" (47-504) MTB tyre, 1/2" hub, High Friction pushrim	C7	213,00 €
D1513	Offroad wheel 24" x 1.75 (47-504) MTB tyre, 12 mm hub, stainless steel pushrim	C7	213,00 €
21824F	Offroad wheel 24" x 1.75 (47-504) MTB tyre, 1/2" hub, stainless steel pushrim	C7	213,00 €
21834T	Twin offroad wheel, 2 x 24" x 1.75 (47-507), MTB tyre, 1/2" bearings, black alu pushrim	C17	522,00 €
21834C	Outdoor Extreme wheel 24" x 2.10" (54-507) MTB, black aluminium handrim	C9	298,00 €
D1523	Outdoor Extreme wheel 24" x 2.10" (54-507) MTB, bearings 1/2", black alum. pushrim	C9	298,00 €
21534S	24" heavy duty wheel, black ø12 mm hub, 1 3/8" PU-tires silver aluminium pushrim	C4A	213,00 €
21534T	24" heavy duty drumbrake wheel, ø12 mm hub, incl. 1 3/8" PU-tires and 6H silver alu. pushrim	C4B	240,00 €
21834F	FAT WHEEL 24" x 1.95" (50-507), hub 12 mm, with tyre and black aluminium pushrim	C8	277,00 €
D1522	FAT WHEEL 24" x 1.95" (50-507), hub 1/2", with tyre and black aluminium pushrim	C8	277,00 €

Standard quick release axles

Item nr.	Description	Foto	Price
219131	Quick release axle $\varnothing 8$ x 25 mm	C28	36,00 €
219008	Quick release axle $\varnothing 12$ x 85 mm	C28	25,50 €
219001	Quick release axle $\varnothing 12$ x 98 mm	C28	25,50 €
219002	Quick release axle $\varnothing 12$ x 104 mm	C28	25,50 €
219003	Quick release axle $\varnothing 12$ x 108 mm	C28	25,50 €
219006	Quick release axle $\varnothing 12$ x 112 mm	C28	25,50 €
219004	Quick release axle $\varnothing 12$ x 123 mm	C28	25,50 €

219101	Quick release axle $\varnothing 1/2$ " x 99 mm	C28	25,50 €
219102	Quick release axle $\varnothing 1/2$ " x 104 mm	C28	25,50 €
219104	Quick release axle $\varnothing 1/2$ " x 108 mm	C28	25,50 €
219103	Quick release axle $\varnothing 1/2$ " x 112 mm	C28	25,50 €
219107	Quick release axle $\varnothing 1/2$ " x 118 mm	C28	25,50 €
219105	Quick release axle $\varnothing 1/2$ " x 122 mm	C28	25,50 €
219108	Quick release axle $\varnothing 1/2$ " x 130 mm	C28	25,50 €

Quick release axles with big button

Item nr.	Description	Foto	Price
219302	Quick release axle $\varnothing 12$ x 99 mm black pushbutton for Ultralite	C29A	27,50 €
219303	Quick release axle $\varnothing 12$ x 104 mm black push button for std.hub	C29A	27,50 €
219304	Quick release axle $\varnothing 12$ mm x 108 mm silver pushbutton for std hub	C29	27,50 €
219308	Quick release axle $\varnothing 12$ x 108 mm with black push button for std. hub	C29A	27,50 €
219306	Quick release axle $\varnothing 12$ x 118 mm with silver pushbutton for standard hub	C29	27,50 €
219305	Quick release axle $\varnothing 12$ x 118 mm black pushbutton	C29S	27,50 €

219407	Quick release axle $\varnothing 1/2$ " x 94 mm with black push button for std hub	C29A	27,50 €
219401	Quick release axle $\varnothing 1/2$ " x 99 mm with black push button	C29A	27,50 €
219402	Quick release axle $\varnothing 1/2$ " x 101 mm with black pushbutton for standard h�ub	C29A	27,50 €
219404	Quick release axle $\varnothing 1/2$ " x 104 mm black push button	C29A	27,50 €
219405	Quick release axle $\varnothing 1/2$ " x 112 mm with black push button for standard hub	C29S	27,50 €
219409	Quick release $\varnothing 1/2$ " x 118 mm with black push button for Ultralite wheel	C29A	27,50 €

Quick release axles for Ultralite Hub

Item nr.	Description	Foto	Price
219302	Quick release axle $\varnothing 12$ x 99 mm black pushbutton for Ultralite	C29A	27,50 €
219401	Quick release axle $\varnothing 1/2$ " x 99 mm with black push button	C29A	27,50 €
219403	Quick release axle $\varnothing 1/2$ " x 104 mm for X-core wheels with silver pushbutton	C29A	27,50 €
219406	Quick release axle $\varnothing 1/2$ " x 108 mm black push button for Ultralite wheel	C29A	27,50 €

Spinergy quick release axles for R10 hub

Item nr.	Description	Foto	Price
219601	Spinergy Quick release 5/8" x 4.25" for R10 bearings	C28	117,00 €
219602	Spinergy Quick release 5/8" x 4.75" for R10 bearings	C28	117,00 €

Various quick release axles, bushings and nuts

Item nr.	Description	Foto	Price
219411	Quick release axle $\varnothing 1/2$ " x 122 mm with tetragrip	C29C	49,00 €
219905	Tetra grip for quick release axles	C29D	41,50 €
219122	Quick release axle $\varnothing 1/2$ " x 104 mm, chrome plated	C28	9,50 €
219201	Bushing $\varnothing 12$ x 50 mm, M16 x 1	C30A	13,00 €
219202	Bushing $\varnothing 12$ x 60 mm, M16 x 1	C30A	15,00 €
219203	Bushing $\varnothing 12$ x 75 mm, M16 X 1	C30A	17,00 €
219210	Bushing $\varnothing 1/2$ " x 51 mm	C30B	19,00 €
219501	Nut M16 x 1, Diameter 24 mm	C31	1,00 €
219502	Nut M18 x 1, Diameter 24 mm	C31	1,25 €

Accessories for rear wheels

Item nr.	Description	Foto	Price
227011	Inner cable with "pear" formed nipple, 180 cm	C34H	1,50 €
227012	Inner cable with "barrel" formed nipple, 180 cm	C34A	1,50 €
227013	Inner cable with "ball" formed nipple, 180 cm	C34H	1,50 €
227018	Inner cable, double with 2 wires, ø1.5 mm x 180 cm	C34I	10,50 €
227060	Inner cable 180 cm with "barrel" formed nipple, box with 100 psc	C36A	96,00 €
227021	Outer cable 550 mm	C34C	1,50 €
227022	Outer cable 800 mm	C34C	2,00 €
227023	Outer cable 900 mm	C34C	2,25 €
227024	Outer cable 1200 mm	C34C	2,50 €
227026	Outer cable 1400 mm	C34C	2,75 €
227050	Outer cable ø5 mm, 50 m in box	C36	49,00 €
227002	Cable adjuster M6 x 25 mm	C34E	1,75 €
227003	Screw clamp ø8 x 15 mm	C34F	1,50 €
227006	Screw clamp ø5 x 7.5 mm	C34F	0,90 €
227004	Closing clamp for inner cable	C34G	0,10 €
227005	Nipple ø8 x 15 mm for rollator	C34J	2,75 €
227007	End cover from metal for ø5 mm cables	C34D	0,20 €
227008	End cover from metal for ø6 mm cables	C34D	0,20 €
227009	End cover from plastic for ø5 mm cables	C34D	0,25 €
229001	Screw 5 x 40 mm	C35A	0,30 €
229002	Distance tube 5.2 x 26 mm	C35B	0,20 €
229512	Screw M5 x 12 mm, bag with 10 pcs	A28E	2,25 €
229003	Mounting fitting for pushrim	C35E	0,20 €
215820	Rim tape for 20"	C37	1,00 €
215822	Rim tape for 22"	C37	1,00 €
215824	Rim tape for 24"	C37	1,00 €
215826	Rim tape for 26/28"	C37	1,50 €
215821	Herrmans rim tape for 20/22" wheels	C37	1,50 €
215825	Heerrmans rim tape for 24"	C37	1,25 €
215827	Herrmans rim tape for 26/28" wheels	C37	1,75 €
215851	Roll with 25 m x 15 mm high pressure self adhesive rim tape - Schwalbe	C37	34,00 €
215852	Roll with 25 m x 18 mm high pressure self adhesive rim tape - Schwalbe	C37	34,00 €
215853	Roll with 50 m x 15 mm self adhesive rim tape - Schwalbe	C37	32,00 €
215854	Roll with 50 m x 19 mm self adhesive rim tape - Schwalbe	C37	32,00 €
215810	Reflector for spoke wheel	C32	1,25 €
231000	Bearing, d=ø8 x D=ø22 x B=7 mm - 608 2RS	C33	5,25 €
231001	Bearing, d=ø10 x D=ø26 x B=8 mm - 6000RS	C33	5,25 €
231002	Bearing, d=ø12 x D=ø28 x B=8 mm - 6001RS	C33	5,25 €
231101	Bearing, d=ø1/2" x D=ø28 x B=5/16" - R8 2RS	C33	7,50 €
231102	Bearing, d=ø1/2" x D=ø1 1/8" x B=5/16" - R8 2RS	C33	5,25 €
231103	Bearing, d=ø12 x D=ø1 1/8" x B=5/16" - 2RS	C33	7,50 €
231201	Bearing, d=ø12 x D=ø32 x B=10 mm - 6201 2RS	C33	7,50 €
231104	Bearing, d=ø15 x D=ø28 x H=7mm - 61902 2RS	C33	9,50 €
231202	Bearing, d=ø15 x D=ø32 x B=9 mm - 6002 2RS	C33	7,50 €
231203	Bearing, d=ø15 x D=ø35 x B=11 mm - 6202 2RS	C33	7,50 €
231205	Bearing, d=ø20 x D=ø42 x B=12 mm - 6004 2RS	C33	13,00 €
231990	Bearing, d=ø10 x D=ø26 - 6000 2RS, stainless	C33	6,50 €
231991	Bearing, d=ø12 x D=ø28 x B=8 mm - 6001 2RS, stainless	C33	8,50 €
231992	Bearing, d=ø1/2" x D=ø1 1/8" x B=5/16" - R8 2RS, stainless	C33	10,50 €
231099	Box with 50 assorted bearings (9 types)	C33	179,00 €
231899	Tool for mounting bearings on rear wheels	C39	27,50 €

Spinergy wheels

Spinergy is a pioneer in the development of revolutionary wheels in the world of wheelchair sports and for everyday use. Spinergy wheels with fibre spokes offer very smooth rolling without annoying spoke creaking and despite their ultralight and modern design they are extremely reliable and low-maintenance.

The various possible combinations and spoke colours are available in 22", 24", 25", 26" and 28" sizes. The Spinergy wheels are supplied as standard with 1/2" ball bearings (except R10 hub), without pushrims and without tyres. Spinergy wheels with a Mobilex article number (see price list) are normally on stock. Other Spinergy models can be supplied on request, however it is possible that longer delivery times may occur.

On request, we can also supply Spinergy wheels as complete wheels, i.e. with pushrims and tyres. We can also offer individual spoke colours and designs, hubs and/or rims. Please see the section "**Spinergy Design Lab**" and refer to our price list for the additional costs.



The **Spox Everyday L** wheel is responsive, extremely durable and ideal for contact sports. If you need a lightweight, fast accelerating and agile wheel, the Spox Everyday L could be your answer. This wheel is stylish and looks fantastic.



An inexpensive wheel in the proven Spinergy® design. The **Spox Sport SL** is an excellent all-purpose wheel designed for durability without compromising style or performance. Ideal for contact sports such as tennis, basketball etc.



Designed for people looking for a unique, innovative style, the **Lite Extreme LX** is aesthetically pleasing and is designed to reduce the weight of your wheelchair without compromising its durability and performance.



Designed for people looking for performance, style and extra torsional stiffness in their wheel choices. Spinergy's **Lite Extreme LX X-Laced** is designed for maximum torsional stiffness and responsiveness.

Foto CX1c



The **Sport Lite Extreme SLX** wheel is responsive, extremely durable and ideal for contact sports enthusiasts. If you need a lightweight, fast accelerating and agile wheel, the Sport Lite Extreme could be your answer. This wheel looks fantastic, is stylish and allows you to focus on the game, not on equipment failures.

Foto CX1g



The latest design evolution from Spinergy that takes wheel performance to the next level. The **Sport Lite Extreme SLX X-Laced** wheel offers extra torsional strength and faster response. Designed for athletes who demand even more from a wheel.

Foto CX1e



The **Blade LXL** is an incredibly stylish and aesthetically pleasing wheel with a clear design that never compromises performance and durability. The Blade LXL has a 17 mm wide rim, a new minimalist hub design and of course the patented PBO fibre spokes.

Blade spokes: The blade spokes take this model to a new level. Each spoke is a blade shape to create a slim and innovative styling similar to high-end aero bicycles.

Foto CX1h



The **Carbon Blade CLX** wheel is the lightest high-performance wheelchair wheel on the market. The carbon fibre rim delivers a level of performance never seen before! Industry experts claim this is the most efficient wheel ever developed. It's lightweight, incredibly responsive, super durable and probably the most beautiful wheel set on the market.

The CLX wheel has a carbon fibre rim, a specially manufactured CNC hub and of course the patented PBO fibre spokes in blade form.

Spinergy LX Flexrim

The Spinergy LX wheel with FLEXRIM is a revolutionary product that is changing the way people roll. With the urethane material holding the pushrim onto the rim, it allows the user to push with out ever touching the tire. The ultra-light and extremely strong material allows the pushrim to flex in and give the wheelchair user an extra inch or so when squeezing into very tight doorways. This product is unlike anything offered by any other company and a must have for everyday users of wheelchairs.

Note:
Rim and handrim are ONE product and cannot be separated.



Foto CY1f

Spinergy wheels - Technical sheet

Wheel type	Hub width	Hub type	Pict.	Spokes Diameter	Spokes Number	Max load per wheel	Weight per wheel
<i>Spox Everyday L</i>	1,80" - 46,5 mm	Standard	CX1a	3 mm	18	75 kg	720 g
<i>Spox Sport SL</i>	2,30" - 60,0 mm	Large	CX1p	3 mm	24	75 kg	760 g
<i>Lite Extreme LX</i>	1,80" - 46,5 mm	CNC milled	CX1b	4 mm	12	75 kg	660 g
<i>Lite Extreme X-Laced XLX</i>	1,80" - 46,5 mm	CNC milled	CX1q	4 mm	12	75 kg	680 g
<i>Sport Lite Extreme SLX</i>	2,30" - 60,0 mm	Large	CX1c	4 mm	24	125 kg	780 g
<i>Sport Lite Extreme X-Laced XSLX</i>	2,30" - 60,0 mm	Large	CX1g	4 mm	24	125 kg	780 g
<i>Sport Lite Extr. X-Laced XSLX R-10</i>	2,30" - 60,0 mm	Large	CX1l	4 mm	24	125 kg	800 g
<i>Blade LXL</i>	1,80" - 46,5 mm	Lite	CX1e	flat	18	75 kg	580 g
<i>Carbon Blade CLX</i>	1,80" - 46,5 mm	Lite	CX1i	flat	18	75 kg	560 g

Spinergy	22"	24"	25"	26"	28"
ETRTO (mm)	501	540	559	590	622

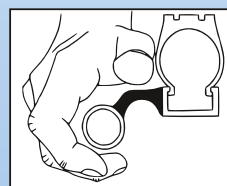
Spinergy hub types



Spinergy standard hub, 1,87" or 2,30", 1/2" bearings, black or silver coloured for L, LS, SLX wheels

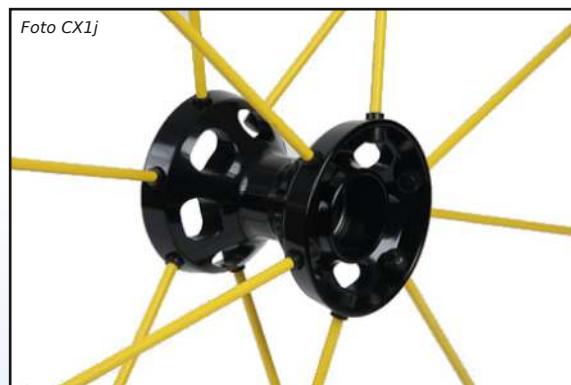

Spinergy CNC milled hub, 1,80", 1/2" bearings, black or silver coloured for LX wheels



Spinergy CNX milled hub 2,30", 1/2" bearings, red or black for XSLX wheel



Spinergy CNX milled hub 2,30", 1/2" bearings, red or black for XSLX wheel



Spinergy CNC milled hub, 1,80", 1/2" bearings, black or silver coloured for LX wheels



The XLSX Hub Cap mounted

Spinerger DESIGN LAB



Foto CX1u
Complete wheel with 9 different spoke colours

For the Spinerger models LX, XLX, LXL, LXL Blade, SLX and XSLX there is the possibility to **personalize the wheels with an individual colour design**. Through the combination of 6 rim-, 6 hub- and 9 different spoke-colours there are almost no limits to your personal taste and design - enjoy yourself!

Possible colours:

Rim: black, blue, gold, red, purple, green
Hub: gold, black, red, purple, green, blue, silver.
Spokes: pink, green, orange, black, white, red, yellow, blue, purple.

It is also possible to assign a different colour to each spoke, both the inner and the outer ones.

The delivery time for individually designed Spinerger wheels is approx. 12 weeks. Please see our price list for additional costs.

ATTENTION: Individually designed wheels cannot be returned!



Spinerger complete wheels

On request, we can also supply all our Spinerger wheels as complete wheels, i.e. with mounted pushrims and/or with mounted tyres. Please refer to our price list for additional costs.

Spinerger LX Offroad



Foto CX1t
Spinerger LX Offroad complete wheel

Outdoor Wheel Package

During the development of Spinerger Offroad wheels, particular attention was paid to high efficiency and good driving characteristics. The rim corresponds to the Spinerger LX model and is supplied with 1/2" bearings as standard. It is available in 24" (22" rim) and 26" (24" rim).

Hub width: 46,5 mm
Max. load: 75 kg per wheel

Complementary products for Spinerger wheels (see also leaflets A and PTe)



Foto A27
Front wheels matching the Spinerger® spoke colours



Foto A2
Aluminium front wheel with black rubber tyre



Foto A26
Black fibre wheels



Foto PTe8
Spinerger wheel bag for 2 wheels from 22" to 28"

Spinergy standard wheels

Spinergy wheels with standard colours (normally on stock). All models not listed can also be ordered, but in this case the delivery time is approx. 12 weeks.

22" Spinergy wheels

Item nr.	Description	Foto	Price
21822A	22" Spinergy Lite Extreme LX, black Hub, 12 black spokes	CX1B	490,00 €
21822Z	22" Spinergy Lite Extreme LX, black hub, 12 white spokes	CX1B	490,00 €

24" Spinergy wheels

Item nr.	Description	Foto	Price
21824A	24" Spinergy Spox Everyday L, silver hub, 18 black spokes	CX1A	405,00 €
218343	24" Spinergy Spox Everyday L, black rim, black hub, 18 black spokes	CX1A	405,00 €
21824B	24" Spinergy Spox Everyday L, black hub, 18 red spokes	CX1A	405,00 €
21824C	24" Spinergy Spox Everyday L, black hub, 18 yellow spokes	CX1A	405,00 €
21824D	24" Spinergy Spox Everyday L, black hub, 18 blue spokes	CX1A	405,00 €
21824E	24" Spinergy Spox Everyday L, black hub, 18 white spokes	CX1A	405,00 €
218231	24" Spinergy Spox Everyday L, black hub, 18 green spokes	CX1A	405,00 €

21834P	24" Spinergy Everyday, 18 spokes in 9 colors	CX1U	362,00 €
--------	--	------	----------

218348	24" Spinergy Spox Sport Everyday SL wheel, silver hub, 24 black spokes	CX1P	405,00 €
--------	--	------	----------

21824U	24" Spinergy Lite Extreme LX, black rim, silver hub, 12 black spokes	CX1B	490,00 €
21824R	24" Spinergy Lite Extreme LX, black hub, 12 black spokes	CX1B	490,00 €
21824V	24" Spinergy Lite Extreme LX, black hub, 12 red spokes	CX1B	490,00 €
21824X	24" Spinergy Lite Extreme LX, black Hub, 12 Yellow spokes	CX1B	490,00 €
21824Y	24" Spinergy Lite Extreme LX, black Hub, 12 blue spokes	CX1B	490,00 €
21824Z	24" Spinergy Lite Extreme LX, black Hub, 12 white spokes	CX1B	490,00 €
21824T	24" Spinergy Lite Extreme LX, black hub, 12 orange spokes	CX1B	490,00 €
21824S	24" Spinergy Lite Extreme LX, black rim, black hub, 12 green spokes	CX1B	490,00 €
218243	24" Spinergy Lite Extreme LX" black hub, 12 purple spokes	CX1B	490,00 €
21834Q	24" Spinergy Lite Extreme LX, black hub, 12 pink spokes	CX1C	490,00 €

218244	24" Spinergy Lite Extreme LX, silver hub with 12 black spokes, FLEXRIM	CY1F	831,00 €
--------	--	------	----------

218245	24" Spinergy Blade LXL, black hub with 18 black spokes	CX1E	490,00 €
--------	--	------	----------

21834K	24" Spinergy X-laced Lite Extreme XLX, silver hub, 12 black spokes	CX1Q	511,00 €
21834L	24" Spinergy X-laced Lite Extreme XLX, black hub, 12 black spokes	CX1Q	511,00 €
21834M	24" Spinergy X-laced Lite Extreme XLX, black hub, 12 white spokes	CX1Q	511,00 €
21834H	24" Spinergy X-laced Lite Extreme XLX, black hub, 12 red spokes	CX1Q	511,00 €
21834G	24" Spinergy X-laced Lite Extreme XLX, black hub, 12 blue spokes	CX1Q	511,00 €

21834B	24" Spinergy Sport Lite Extreme SLX, black hub, 24 black spokes	CX1C	490,00 €
21824J	24" Spinergy Sport Lite Extreme SLX, silver hub, 24 black spokes	CX1C	490,00 €
21824K	24" Spinergy Sport Lite Extreme SLX, black hub, 24 red spokes	CX1C	490,00 €
21824M	24" Spinergy Sport Lite Extreme SLX, black Hub, 24 Yellow spokes	CX1C	490,00 €
21824N	24" Spinergy Sport Lite Extreme SLX, black Hub, 24 blue spokes	CX1C	490,00 €
21824P	24" Spinergy Sport Lite Extreme SLX, black Hub, 24 white spokes	CX1C	490,00 €
21824H	24" Spinergy Sport Lite Extreme SLX, black hub, 24 orange spokes	CX1C	490,00 €
21824I	24" Spinergy Sport Lite Extreme SLX, black hub, 24 green spokes	CX1C	490,00 €

218241	24" Spinergy X-Laced Sport Lite Extreme XSLX, black hub with 24 black spokes	CX1G	511,00 €
218246	24" Spinergy X-Laced Sport Lite Extreme XSLX, black hub with 24 white spokes	CX1G	511,00 €
218249	24" Spinergy X-Laced Sport Lite Extreme XSLX, black hub with 24 red spokes	CX1G	511,00 €

21824G	24" Spinergy Sport Lite Extreme X-Laced X-SLX, red R10 5/8" hub, 24 black spokes	CX1L	511,00 €
--------	--	------	----------

21834A	24" Spinergy Extra Lite Carbon Blade CLX, black hub, 18 black spokes	CX1H	618,00 €
--------	--	------	----------

25" Spinergy wheels

Item nr.	Description	Foto	Price
21825A	25" Spinergy Spox Everyday L, silver hub, 18 black spokes	CX1A	426,00 €
21825B	25" Spinergy Spox Everyday L, black hub, 18 black spokes	CX1A	426,00 €
21825C	25" Spinergy Spox Everyday L, black hub, 18 blue spokes	CX1A	426,00 €
218358	25" Spinergy Spox Sport Everyday SL, silver hub, 24 black spoke	CX1P	426,00 €
21825M	25" Spinergy Lite Extreme LX, silver Hub, 12 black spokes	CX1B	533,00 €
21825N	25" Spinergy Lite Extreme LX, black hub, 12 black spokes	CX1B	533,00 €
21825Z	25" Spinergy Lite Extreme LX, black hub, 12 white spokes	CX1B	533,00 €
21825T	25" Spinergy Lite Extreme LX, black hub, 12 orange spokes	CX1B	533,00 €
21825Y	25" Spinergy Lite Extreme LX, black Hub, 12 blue spokes	CX1B	533,00 €
21825L	25" Spinergy X-laced Lite Extreme XLX, black hub with 12 black spokes	CX1Q	554,00 €
21825H	25" Spinergy Sport Lite Extreme SLX, silver hub, 24 black spokes	CX1C	533,00 €
218252	25" Spinergy X-Laced Sport Lite Extreme XSLX, silver hub, 24 black spokes	CX1G	533,00 €
218251	25" Spinergy X-Laced Sport Lite Extreme XSLX, black hub, 24 black spokes	CX1G	533,00 €
21825G	25" Spinergy X-Laced Sport Lite Extreme XSLX, red R10 5/8" hub, 24 black spokes	CX1G	533,00 €
21835A	25" Spinergy Extra Lite Carbon Blade CLX, black hub 18 black spokes	CX1H	628,00 €

26" Spinergy wheels

Item nr.	Description	Foto	Price
21826A	26" Spinergy Spox Everyday L, silver hub, 18 black spokes	CX1A	447,00 €
218368	26" Spinergy Spox Sport Everyday SL, silver hub, 24 black spokes	CX1P	447,00 €
21826M	26" Spinergy Lite Extreme LX, silver Hub, 12 black spokes	CX1B	554,00 €
21826R	26" Spinergy Lite Extreme LX, black hub, 12 black spokes	CX1B	554,00 €
21826Z	26" Spinergy Lite Extreme LX, black hub, 12 white spokes	CX1B	554,00 €
21826X	26" Spinergy Lite Extreme LX, black hub, 12 yellow spokes	CX1B	554,00 €
21826H	26" Spinergy Sport Lite Extreme SLX, silver hub, 24 black spokes	CX1C	554,00 €
218261	26" Spinergy X-Laced Sport Lite Extreme XSLX, black hub, 24 black spokes	CX1G	554,00 €
21826G	26" Spinergy X-Laced Sport Lite Extreme XSLX, red R10 5/8" hub, 24 black spokes	CX1L	554,00 €

28" Spinergy wheels

Item nr.	Description	Foto	Price
21828H	28" Spinergy Sport Lite Extreme SLX, silver hub, 24 black spokes	CX1C	554,00 €

Spinergy Outdoor Wheel Package

Item nr.	Description	Foto	Price
21824W	24" Spinergy Offroad LX with tyre and aluminium pushrim, silver hub, 12 black spokes	CX1T	618,00 €
21826W	26" Spinergy Offroad LX with tyre and aluminium pushrim, silver hub, 12 black spokes	CX1T	618,00 €

24" Spinergy complete wheel with 9 spoke colors (e.g. for exhibition or advertising)

Item nr.	Description	Foto	Price
21834N	24" Spinergy Everyday wheel with 18 spokes in 9 colors with tyre and pushrim	CX1U	426,00 €

Spinergy DESIGN LAB

Custom colours for Spinergy wheels (delivery time approx. 12 weeks)

Item nr.	Description	Foto	Price
D3140	Spinergy Design Lab - Custom build with hub and rim colors and also spokes		149,00 €
D3141	Spinergy Design lab - custom spoke color		64,00 €

Spinergy pushrims

Item nr.	Description	Foto	Price
21724X	24" Spinergy TC Max, ergonomic oval pushrim, stainless steel with 6 splices	CY11	548,00 €
21724Q	24" Spinergy TC Stainless pushrim, stainless steel with 6 splices	CY11	405,00 €

Spinergy accessories and spare parts

Item nr.	Description	Foto	Price
218903	Spinergy rimpape, 24"	CX1V	4,25 €
218904	Spinergy rimpape, 25"	CX1V	4,25 €
218905	Spinergy rimpape, 26"	CX1V	4,25 €

218920	Spinergy protective pub cap for XSLX model wheels	CX1S	38,50 €
--------	---	------	---------

279035	Spinergy wheel bag for 2 wheels - 20" - 28"	PTE8	213,00 €
--------	---	------	----------

218400	Nipple for 3 mm Spinergy Everyday spoke		2,25 €
218500	Nipple for 4 mm Spinergy LX/SLX spoke		2,25 €

Fitting of pushrims, tyres and Flexel

Item nr.	Description	Price
D3130	Fitting of pushrim on wheel	21,50 €

D3110	Fitting of tyre and tube on wheel	21,50 €
D3120	Fitting of PU tyres on wheel	21,50 €
D3121	Mounting of Flexel on wheels	32,00 €

D1345	Replacing the bearings on Spinergy wheels	free
-------	---	------

Spokes

Description	Ø	Color	Item nr. 24"	Item nr. 25"	Item nr. 26"	Item nr. 28"	Price
Spoke for Everyday wheel	3 mm	black	218401	218501	218601	218801	11,50 €
Spoke for Everyday wheel	3 mm	blue	218402	218502	218602	---	11,50 €
Spoke for Everyday wheel	3 mm	red	218403	218503	218603	---	11,50 €
Spoke for Everyday wheel	3 mm	yellow	218404	218504	218604	---	11,50 €
Spoke for Everyday wheel	3 mm	white	218405	218505	218605	---	11,50 €
Spoke for Everyday wheel	3 mm	orange	218406	218506	218606	---	11,50 €
Spoke for Everyday wheel	3 mm	green	218407	218507	218607	---	11,50 €
Spoke for Everyday wheel	3 mm	purple	218408	218508	218608	---	11,50 €
Spoke for Everyday wheel	3 mm	pink	218409	218509	218609	---	11,50 €

Spoke for LX/SLX wheel	4 mm	black	218411	218511	218611	218811	16,00 €
Spoke for LX/SLX wheel	4 mm	blue	218412	218512	218612	---	16,00 €
Spoke for LX/SLX wheel	4 mm	red	218413	218513	218613	---	16,00 €
Spoke for LX/SLX wheel	4 mm	yellow	218414	218514	218614	---	16,00 €
Spoke for LX/SLX wheel	4 mm	white	218415	218515	218615	---	16,00 €
Spoke for LX/SLX wheel	4 mm	orange	218416	218516	218616	---	16,00 €
Spoke for LX/SLX wheel	4 mm	green	218417	218517	218617	---	16,00 €
Spoke for LX/SLX wheel	4 mm	purple	218418	218518	218618	---	16,00 €
Spoke for LX/SLX wheel	4 mm	pink	218419	218519	218619	---	16,00 €

Blade spoke (external)	flad	black	21841A	21851A	---	---	19,00 €
Blade spoke (internal)	flad	black	21841B	21851B	---	---	19,00 €

Note: The Spinergy spokes come complete with nipples

Nipples

Item nr.	Description	Price
218400	Nipple for 3 mm Spinergy Everyday spoke	2,25 €
218500	Nipple for 4 mm Spinergy LX/SLX spoke	2,25 €

Overview for pushrims and tyres for Spinerger wheels

ATTENTION: As standard we deliver Spinerger wheels without pushrim and without tyre. Please use the tables below if you want to order Spinerger wheels completely.

Pushrims for Spinerger wheels (without assembly - assembly costs see on page before)

Pushrim - item nr.	weight (24")	24"	25"	26"	28"
Pushrim aluminium silver	0,32 kg	21724B	21725B	21726B	21728B
Pushrim aluminium black	0,32 kg	217248	217258	217268	--
Pushrim stainless	0,66 kg	217244	217254	217264	--
Pushrim titanium	0,42 kg	21724T	21725T	21726T	21728T
Pushrim friction "soft"	0,64 kg	217241	--	217261	--
Pushrim friction "hard"	0,58 kg	217242	--	217262	--
Pushrim Spinerger TC	0,50 kg	21724Q	--	--	--
Pushrim Spinerger TC-Grip	0,56 kg	21724P	--	--	--
Pushrim Mobilex Topgrip	0,64 kg	21724V	21725V	--	--
Pushrim Mobilex Trigrip	0,72 kg	21724Z	--	--	--

Tyres for Spinerger wheels (without assembly - assembly costs see on page before)

Tyre / tube - item nr.	24" tube / tyre	25" tube / tyre	26" tube / tyre	28" tube / tyre
1" Standard tyre	207242 / 205241	207251 / 205251	207261 / 205261	n.a.
1" Schwalbe Marathon+	207246 / 20524Y	207252 / 205253	207264 / 205266	n.a.
1" Schwalbe Marathon+ Refl.	207246 / 20524A	n.a.	207264 / 205267	n.a.
1" Schwalbe One	207246 / 20524W	207252 / 20525A	n.a.	n.a.
1" Schwalbe DownTown	207246 / 20524Z	n.a.	n.a.	n.a.
1" Schwalbe RightRun black	207246 / 205343	n.a.	n.a.	n.a.
1" Schwalbe RightRun grey	207246 / 20524L	207252 / 205254	207264 / 205263	n.a.
1" Schwalbe RightRun blue	207246 / 20524T	n.a.	n.a.	n.a.
1" Schwalbe RightRun red	207246 / 20524X	n.a.	n.a.	n.a.
1" Kenda K-191 blue/black	207242 / 20524E	n.a.	207262 / 20526E	n.a.
1" Kenda K-191 red/black	207242 / 20524V	207251 / 205257	207262 / 205269	207281 / 205285
1" Kenda K-191 grey/black	207242 / 20524N	207251 / 205258	207262 / 20526A	n.a.
1" Kenda K-1053 black	207242 / 20524O	n.a.	n.a.	n.a.
1" Kenda K-196 grey	n.a.	n.a.	207261 / 20526A	n.a.
1" Kenda K-196 red	n.a.	n.a.	207261 / 205269	207281 / 205285
1" Cheng Shin VN Master	207242 / 205347	--	--	--

PU tyres - item nr.	PU 24"	PU 25"	PU 26"	PU 28"
1" PU tyre grey	211243	211251	211262	n.a.
1" PU tyre black	211248	211252	211263	n.a.

n.a. = not available

Plastic



Black plastic pushrim. Available for mounting with bolts or clips.

Aluminium silver



Pushrim made from aluminium available for mounting with splices, bolts or clips.

Aluminium black



Pushrim made from black aluminium available for mounting with splices, bolts or clips.

Stainless steel



Stainless steel pushrim. Available brushed or polished for mounting with splices, bolts or clips.

Titanium



Titanium pushrim. Available for mounting with splices only.

Silicone



Aluminium pushrim with black silicone coating. Available for mounting with bolts or clips.

High Friction Medium Soft



Aluminium pushrim with black silicone coating. Available for mounting with bolts or clips.

High Friction Medium Hard



Aluminium pushrim with black medium-hard High Friction coating. Available for mounting with splices only.

With rubber knobs



Black aluminium pushrim with 9 rubber knobs. Available for mounting with splices only.

Fitting of pushrims



Fitting with splices



Fitting with rivet



Fitting with clips

Fitting parts

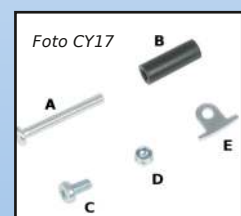

Mobilex Top-Grip



The oval **Mobilex Top-Grip** push-rims have an anti-slip insert and offer a better grip that makes the wheelchair more manoeuvrable and easier to drive. The smooth black hard anodized aluminum sides minimize frictional heat during braking.

Spinergy TC stainless

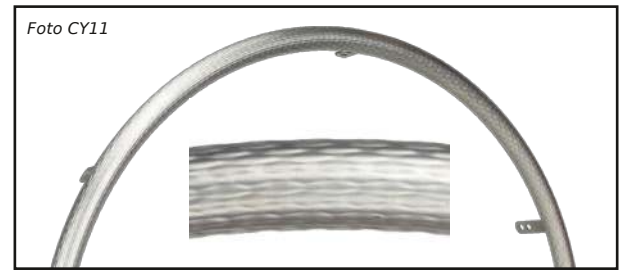

The **Spinergy TC** pushrim is made of lightweight stainless steel and has a textured surface that combines high grip with stability and hardness, especially for a stainless steel pushrim.

The **TC Max** differs in its oval ergonomic shape, which offers a larger gripping surface.

Omobic pushrims (Available only with splices - Only the "Magnesium" pushrim is with rivets)

Optimum H, P and F



Optimum ZH and ZF



The **Omobic Optimum** series pushrims provide optimal contact for easy propulsion and braking and are best suited for users with limited hand strength. The **P model** is powder coated, while the **H and ZH models** are hard anodised. The **F and ZF models**, on the other hand, have a 1.5 mm anti-slip coating.

Nova H and P



Orbit H



Simi



The **Omobic** pushrims of the **Nova**, **Orbit** and **Simi** series have an anti-slip insert made of environmentally friendly silicone. They provide excellent grip, making the wheelchair more manoeuvrable and comfortable to drive. The **Nova P model** is powder coated, while the **Nova H**, **Orbit H** and **Simi models** are hard anodised.

Titanium



Ultralight



Magnesium



Lizard



The **Omobic Ultralight** Aluminium, **Omobic Magnesium** and **Omobic Titanium** pushrims are particularly light and yet very robust. The **Omobic Lizard** push rim made of aluminium offers a high grip due to its 1 mm thick silicone coating with a coefficient of friction of 0.7 and is particularly suitable for quadriplegics.

Mobilex A/S - Price list

All prices are per pcs. and in EUR.

07.2022

Leaflet CY

We have the following pushrims in our standard program

20"	4 straight holes	6 straight holes	4 angled holes	4 splices	6 splices
4 straight holes	--	--	--	--	217203
6 straight holes	21720A	--	217201	21720B	--
4 angled holes	--	--	217207	--	--
4 splices	216201	--	--	--	--
6 splices	217206	--	--	--	--

22"	489 4 holes straight	489 6 holes straight	498/501 4 holes angled	489/501 6 holes straight	489 4 holes angled	498/501 4 holes angled	489 6 splices	489/501 6 splices
Black aluminium	--	--	--	--	--	--	217228	--
Silver aluminium	--	21722A	21722M	--	217226	--	21722B	--
Stainless steel brushed	--	--	--	--	21722E	--	217229	--
Stainless steel polished	--	--	--	--	--	--	21722D	--
Medium hard friction	--	--	--	--	--	--	217225	--
Soft friction	--	--	21722C	21722S	--	217227	217221	--
Black plastic	216225	216221	--	--	216222	--	--	--
Silicone	--	217223	21722Z	--	217224	--	--	--

24"	4 holes straight	6 holes straight	4 holes angled	6 splices	4 splices
Black aluminium	--	21724D	--	217248	21724F
Silver aluminium	--	21724A / 21724R	217247	21724B	--
Stainless steel brushed	--	21724N	21724E	217244	--
Stainless steel polished	--	--	--	21724U	--
Medium hard friction	--	--	--	217242	21724M
Soft friction	--	--	21724H	217241	--
Black plastic	216242	216241	216243	--	--
Silicone	217245	217246	217249	--	--
Titanium	--	--	--	21724T	--
Mobilex Top-Grip	--	--	--	21724V	--
Mobilex Tri-Grip	--	--	--	21724Z	--
Spinergy TCG	--	--	--	21724P	--
Spinergy TC Stainless	--	--	--	21724Q	--

25"	4 holes straight	6 holes straight	4 holes angled	6 splices
Alu black	--	--	--	217258
Alu silver	--	--	--	217257
Stainless steel polished	--	--	--	217254
Friction Medium Hard	--	--	--	217252
Titanium	--	--	--	21725T

26"	4 holes straight	6 holes straight	4 holes angled	6 splices
Black aluminium	--	--	--	217268
Silver aluminium	--	21726A	--	21726B
Stainless steel polished	--	--	--	217264
Medium hard friction	--	--	--	217262
Medium hard Soft	--	--	--	217261
Silicone	--	217266	--	--
Titanium	--	--	--	21726T

28"	4 holes straight	6 holes straight	6 splices	12 splices
Silver aluminium	--	--	21728B	--
Stainless steel polished	--	--	217284	--
Titanium	--	--	--	21728T

Standard pushrims ("Dim." is the distance in mm between the outer side of the splices or between the center of the rivenuts)

Pushrims of plastic

Item nr.	Description	Dim.	Foto	Price
216201	20" Plastic pushrim, black, 4 holes	424	CY1	29,00 €
216225	22" Plastic pushrim, black, 4 holes for ø489 rim	462	CY1	34,00 €
216221	22" Plastic pushrim, black, 6 holes for ø489 rim	462	CY1	29,00 €
216222	22" Plastic pushrim, black, 4 holes for ø489 rim	480	CY1	34,00 €
216242	24" Plastic pushrim, 4 holes	513	CY1	40,50 €
216241	24" Plastic pushrim, 6 holes	513	CY1	29,00 €
216243	24" Plastic pushrim, black, 4 angled holes, for ø540 mm rim	513	CY1	30,00 €

Pushrims of aluminium

Item nr.	Description	Dim.	Foto	Price
21720A	20" Aluminium pushrim, silver, 4 holes	424	CY2	32,00 €
21720B	20" Aluminium pushrim, silver, with 4 splices	435	CY2	44,50 €
217201	20" Aluminium pushrim, silver, 4 angled holes	430	CY2	32,00 €
21722A	22" Aluminium pushrim, silver, 6 holes for ø489 rim	462	CY2	33,00 €
21722B	22" Aluminium pushrim, silver, with 6 splices for ø489 rim	473	CY2	41,50 €
217226	22" Aluminium pushrim, silver, 4 angled holes for ø489 rim	480	CY2	31,00 €
21722M	22" Aluminium pushrim, silver, with 4 holes for ø501 mm rim	501	CY2	33,00 €
21724L	24" Aluminium pushrim, silver, with 4 holes	513	CY2	47,00 €
21724A	24" Aluminium pushrim, silver, 6 splices	513	CY2	25,50 €
21724R	24" Aluminium pushrim silver, 6 holes, Budget type	513	CY2	21,50 €
21724B	24" Aluminium pushrim, silver, 6 splices	513	CY2	32,00 €
217247	24" Alu pushrim, silver, 4 angled holes	513	CY2	31,00 €
21724J	24" Aluminium pushrim, silver, 6 splices for double wall rim	513	CY2	42,50 €
217257	25" Aluminium pushrim, silver, 6 splices	545	CY2	53,00 €
21726A	26" Aluminium pushrim, silver, 6 holes	567	CY2	41,50 €
21726B	26" Aluminium pushrim, silver, 6 splices	567	CY2	47,00 €
21728B	28" Aluminium pushrim, silver, 6 splices	600	CY2	53,00 €

217203	20" Aluminium pushrim, black, 6 splices	435	CY3	42,50 €
217228	22" Aluminium pushrim, black, 6 splices for ø489 rim	473	CY3	44,50 €
21724D	24" Aluminium pushrim, black, 6 holes	513	CY3	39,50 €
21724F	24" Aluminium pushrim, black, 4 splices	524	CY3	44,50 €
217248	24" Aluminium pushrim, black, with 6 splices	524	CY3	39,50 €
217258	25" Aluminium pushrim, black, with 6 splices	545	CY3	50,00 €
217268	26" Aluminium pushrim, black, 6 splices	566	CY3	50,00 €

Pushrims of stainless steel

Item nr.	Description	Dim.	Foto	Price
21722E	22" Pushrim brushed stainless steel, 6 angled holes for ø489 rim	473	CY4	32,00 €
217229	22" Pushrim brushed stainless steel, with 6 splices for ø489 rim	473	CY4	72,00 €
21722D	22" Pushrim polished stainless steel, with 6 splices for ø489 rim	473	CY4	70,00 €
21724E	24" Pushrim brushed stainless steel, 4 angled holes	513	CY4	40,50 €
217244	24" Pushrim brushed stainless steel, 6 splices	524	CY4	36,00 €
21724U	24" Pushrim polished stainless steel, 6 splices	524	CY4	54,00 €
21724N	24" Pushrim brushed stainless steel, 6 holes	524	CY4	41,50 €
217254	25" Pushrim polished stainless steel, 6 splices	545	CY4	67,00 €
217264	26" Pushrim polished stainless steel, 6 splices	567	CY4	78,00 €
217284	28" Pushrim polished stainless steel, 6 splices	600	CY4	81,00 €

Pushrims of titanium

Item nr.	Description	Dim.	Foto	Price
21724T	24" Titanium pushrim, 6 splices for double wall rim	524	CY5	175,00 €
21725T	25" Titanium pushrim, 6 splices for double wall rim	545	CY5	204,00 €
21726T	26" Titanium pushrim, 6 splices for double wall rim	567	CY5	204,00 €
21728T	28" Titanium pushrim, 12 splices for double wall rim	600	CY5	328,00 €

Special pushrims ("Dim." is the distance in mm between the outer side of the splices or between the center of the rivenuts)

Pushrims with silicone

Item nr.	Description	Dim.	Foto	Price
217206	20" Alu/silicone pushrim, 4 holes	513	CY6	128,00 €
217206	20" Alu/silicone pushrim, 4 holes	476	CY6	128,00 €
217223	22" Alu/silicone pushrim, 6 holes for ø489 rim	462	CY6	128,00 €
217225	22" Alu/silicone pushrim, 6 holes for ø498/501 rim	476	CY6	128,00 €
217224	22" Alu/silicone pushrim, 4 angled holes for ø498 rim	480	CY6	128,00 €
217245	24" Alu/silicone pushrim, black, 4 holes	513	CY6	128,00 €
217246	24" Alu/silicone pushrim, black, 6 holes	513	CY6	128,00 €
217249	24" Alu/silicone pushrim, 4 angled holes	513	CY6	128,00 €
217266	26" Alu/silicone pushrim, black, 6 holes	567	CY6	128,00 €

High Friction pushrims

Item nr.	Description	Dim.	Foto	Price
217207	20" Friction pushrim, black, medium soft, 4 angled holes	473	CY7	83,00 €
217221	22" Friction pushrim, black, medium soft, 6 splices for ø489 rim	473	CY7	83,00 €
217227	22" Friction pushrim, black, High Friction medium soft, 4 angled holes for ø498 rim	480	CY7	83,00 €
21722C	22" Friction pushrim, black, medium soft, 4 holes for ø498 rim	480	CY7	83,00 €
217241	24" Friction pushrim, black, medium soft, 6 splices	524	CY7	83,00 €
21724H	24" Friction pushrim, High Friction medium soft, 4 angled holes	513	CY7	83,00 €
217251	25" Friction pushrim, black, medium soft, 6 splices	545	CY7	94,00 €
217261	26" Friction pushrim, black, medium soft, 6 splices	576	CY7	94,00 €

217225	22" Friction pushrim, black, medium hard, 6 splices for ø489 rim	473	CY8	83,00 €
217242	24" Friction pushrim, black, medium hard, 6 splices	524	CY8	83,00 €
21724M	24" Friction pushrim, black, medium hard, with 4 splices	524	CY8	100,00 €
217252	25" Friction pushrim, black, medium hard, with 6 splices	545	CY8	94,00 €
217240	24" Friction pushrim, black, medium hard, 6 splices for dobbelt wall rim	511	CY8	83,00 €
217262	26" Friction pushrim, black, medium hard, with 6 splices	567	CY8	83,00 €

Specially shaped pushrims

Item nr.	Description	Dim.	Foto	Price
21724V	24" TOP-GRIP pushrim with friction insert, black aluminium, 6 splices	510	CY12	107,00 €
21725V	25" TOP-GRIP pushrim with friction insert, black aluminium, 6 splices	535	CY12	117,00 €

Omobic pushrims

Item nr.	Description	Dim.	Foto	Price
21P24A	24" Omobic OPTIMUM H pushrim, black alum. 6 splices (corresponds to TRI GRIP 21724Y)	515	CY21	90,00 €
21P24B	24" Omobic ORBIT H pushrim with friction insert, black aluminium, 6 splices	515	CY24	155,00 €
21P24C	24" Omobic OPTIMUM F friction pushrim, black, 6 splices (corresponds to TRI GRIP 21724Z)	515	CY21	128,75 €
21P24D	24" Omobic OPTIMUM P pushrim, black aluminium, 6 splices	515	CY21	67,50 €
21P24E	24" Omobic SIMI friction pushrim, black, 6 splices	515	CY25	138,75 €
21P24F	24" Omobic OPTIMUM Z H pushrim, black aluminium, 6 splices	515	CY22	108,25 €
21P24G	24" Omobic OPTIMUM Z F friction pushrim, black, 6 splices	515	CY22	131,25 €
21P24H	24" Omobic MAGNESIUM pushrim, white, 6 holes	515	CY28	79,75 €
21P24I	24" Omobic ULTRALIGHT ALUMINIUM pushrim, silver, 6 splices	523	CY27	60,00 €
21P24J	24" Omobic LIZARD GRIP friction pushrim, black, 6 splices	523	CY29	78,75 €
21P24K	24" Omobic TITANIUM pushrim, 6 splices	517	CY26	210,00 €
21P24M	24" Omobic NOVA P pushrim with friction insert, black aluminium, 6 splices	515	CY23	95,00 €
21P24N	24" Omobic NOVA H pushrim with friction insert, black aluminium, 6 splices	515	CY23	107,00 €

Spinergy pushrims

Item nr.	Description	Dim.	Foto	Price
21724Q	24" Spinergy TC Stainless pushrim, stainless steel with 6 splices	515	CY11	405,00 €
21724X	24" Spinergy TC Max, ergonomic oval pushrim, stainless steel with 6 splices	515	CY11	548,00 €

Pushrim with 9 rubber knobs

Item nr.	Description	Dim.	Foto	Price
21724G	24" pushrim 6 splices and 9 alu/rubber knobs	524	CY9	143,00 €

Fitting sets for pushrims

Item nr.	Description	Foto	Price
229009	Distance tube 5.1 x 20 mm	C17B	0,15 €
229002	Distance tube 5.2 x 26 mm	C17B	0,20 €
229010	Distance tube 5.2 x 7 mm	C17B	0,15 €
229005	Locknut M5, bag with 10 pcs	A28D	1,00 €
229003	Mounting fitting for pushrim	C17E	0,20 €
229001	Screw 5 x 40 mm	C17A	0,30 €
229512	Screw M5 x 12 mm, bag with 10 pcs	A28E	2,25 €
22910A	Set with 4 screws, 4 nuts and 4 rubber protection for pushrim with splices	CY14	2,25 €
22910B	Set with 4 screws, 4 plastic tubes and 4 fittings for pushrim with screw thread	CY15	2,25 €
22910C	Set with 6 screws, 6 nuts and 6 rubber protection for pushrim with splices	CY14	3,25 €
22910D	Set with 6 screws, 6 plastic tubes and 6 fittings for pushrim with screw thread	CY15	6,00 €

One-hand drive set for manually operated wheelchairs

The Mobilex one-hand drive set is particularly easy to install and fits all hand-operated wheelchairs that have 16 mm or 18 mm bushings (the hole on the wheelchair frame that holds the bushings for the wheel axles). The assembly of the whole set takes only a few minutes.



Mobilex one-hand drive



Standard telescopic axle



Cardanic telescopic axle



Standard bushing set for mounting plates with a thickness of 10-15 mm



Wide bushing set for mounting plates with a thickness of 15-30 mm



Wheelchair with mounted standard telescopic axle

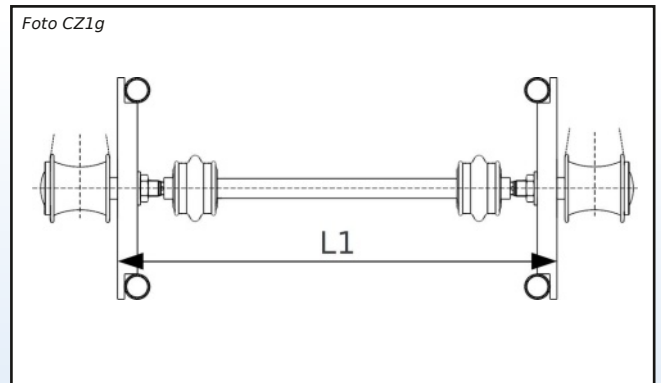

Calculation of the length of the telescopic axle (L1) from frame tube outside left to frame tube outside right

Set for mounting drum brakes on manually operated wheelchairs

Easy to install, the Mobilex drum brake set fits all hand-operated wheelchairs with 16 mm or 18 mm bushings (the hole on the wheelchair frame that holds the bushings for the wheel axles). All parts required for assembly are supplied. If our position lock (CZ2e) is used to lock the brake anchor plate, there must only be one more hole on the frame.



Wheelchair with drum brakes



Brake lever with cable



Anchor plate with quick release axle



Brake fixation (position blocking)

Set for mounting a one-hand drive

The mounting set for the one-hand drive consists of 2 wheels with tyre and tube. The telescopic axles are not included and must be ordered separately. When ordering, the inner distance between the frame tubes must be specified (see drawing / picture C25g).

Mounting kit

Item nr.	Description	Foto	Price
D1606	set for onehanddriving, incl. 2x 22" wheels with tyre, tube, quick release system for ø18 holes	CZ1A	596,00 €
D1607	Set for one-arm-drive consisting of 2 pcs 24" wheels fitted with tyre/tube and quick release system for Ø16/Ø18 mm holes	CZ1A	415,00 €
D1608	Set for one-arm-drive consisting of 2 x 24" wheels fitted with tyre/flexel with quick relea. system for ø16/ø18 mm holes	CZ1A	437,50 €
D1601	Set for one-arm-drive consisting of 2 x 22" wheels fitted with tyre/tube with quick release system for ø16/ø18 mm holes	CZ1A	682,00 €
D1602	Set for one-arm-drive consisting of 2 pcs 24" wheels fitted with tyre/tube with quick release system for Ø18 mm holes	CZ1A	660,00 €
D1603	Set for one-arm-drive consisting of 2 pcs 24" wheels fitted with tyre/flexel with fixed bolt system for ø16 mm holes	CZ1A	682,00 €

Item nr.	Description	Foto	Price
215915	Bushing set for one-hand drive, short model (set only for one side)	CZ1E	40,50 €
215916	Bearing house for one-arm-drive, long model	CZ1F	62,00 €

Telescopic axles for wheelchairs with straight rear wheels (without cambring)

Item nr.	Description	Foto	Price
209042	Teleskopisk axle, standard, length: 185-245 mm for wheelchair width 305-345 mm	CZ1C	68,00 €
209044	Teleskopisk axle, standard, length: 255-345 mm for wheelchair width 375-445 mm	CZ1C	68,00 €
209047	Teleskopisk axle, standard, length: 390-485 mm for wheelchair width 390-485 mm	CZ1C	68,00 €
209046	Teleskopisk axle, standard, length: 310-460 mm for wheelchair width 430-560 mm	CZ1C	68,00 €

Telescopic axles with cardan joint for wheelchairs with rear wheels with cambring

Item nr.	Description	Foto	Price
209053	Teleskopisk axle with cardan and conus, 6 edges de luxe, length: 220-275 mm	CZ1D	192,00 €
209054	Teleskopisk axle with cardan and conus, 6 edges de luxe, length: 255 -315 mm	CZ1D	192,00 €
209055	Teleskopisk axle with cardan and conus, 6 edges de luxe, length: 295 -370 mm	CZ1D	192,00 €
209056	Teleskopisk axle with cardan and conus, 6 edges de luxe, length: 350 -460 mm	CZ1D	192,00 €
209057	Teleskopisk axle with cardan and conus, 6 edges de luxe, length: 420-530 mm	CZ1D	192,00 €

Complete set of 24" wheels with drum brakes

The set includes all parts required to assemble the drum brake wheels. It consists of two 24" wheels with drum brakes, 2 PU tyres 24" x 1 3/8", 2 silver-coloured aluminium pushrims, 2 anchor plates with 2 fixing levers for 16 mm hole and 2 brake handles with cable set.

Item nr.	Description	Foto	Price
D1401	Complete 24" drum brake set (2 wheels with PU tyres and pushrim, brakelevers, brake plates, fixing lever)	C25A	383,00 €

Alternatively, you can assemble drum brake wheels yourself. To do this, select the required parts from the tables below (order covers and pushrims separately!).

Drum brake wheels

Item nr.	Description	Foto	Price
D1220	20" drumbrake-wheel without tyre, tube and pushrim	C2	79,00 €
D1222	22" drumbrake-wheel without tyre, tube and pushrim	C2	79,00 €
D1224	24" drumbrake-wheel without tyre, tube and pushrim	C2	79,00 €

Brake plates

Item nr.	Description	Foto	Price
D1202	brake plate incl. quick release for drumbrake-wheel, left	C22	47,00 €
D1203	brake plate incl. quick release for drumbrake-wheel, right	C22	47,00 €

Accessories for drum brake wheels

Item nr.	Description	Foto	Price
D1204	Cable, handgrip for drumbrake-wheel, pair	C21	47,00 €
215698	Position lock for drumbrake for ø16 mm hole	C4	19,00 €
215699	Position lock for drumbrake for ø18 mm hole	C4	19,00 €

ACCESSORIES

ACCESSORIES



Leaflet D, DX

Accessories, silicone covers,
spoke guards etc.

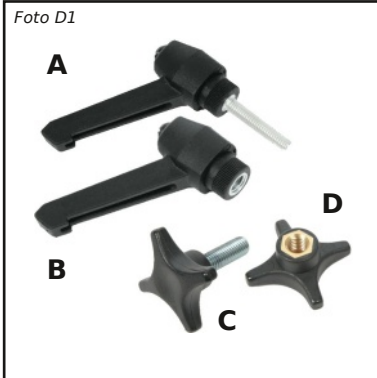

Handle male (A) or female (B) and starhandles male (C) or female (D)



Box with 55 assorted handles and star-handles

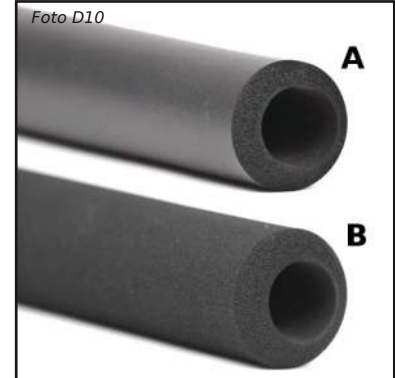

oam cover smooth (A), or with rough surface (B)

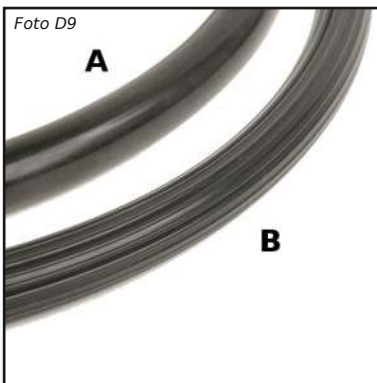

Pushrim cover from silicone (A) smooth, (B) ribbed

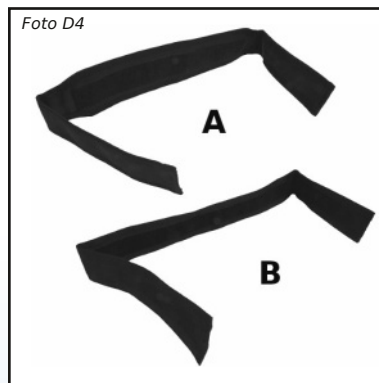

Calf-band adjustable in width (A) height 9 cm, (B) height 5 cm



Safety belts, (A) open, (B) closed and (C) with metal fittings



Front fork from plastic with 14 mm bolt



Front fork from alluminium 120x39, 146x45, 180x60 mm



DSF Dynamic suspension front fork, 131 x 40.5 mm



Universal cane holder + adapter for scooters or el. wheelchairs

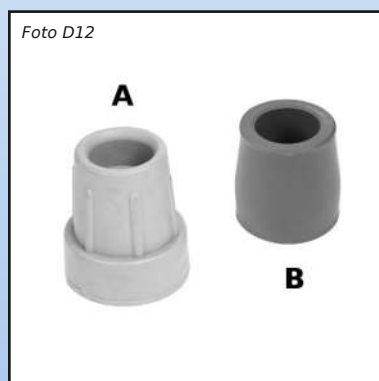

Capsules from grey rubber for crutches (A) or bath chair (B)



Universal Anti-Tip

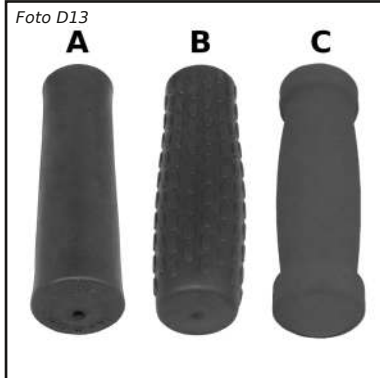

Handgrips



Contoured handgrips



Anatomic handgrips

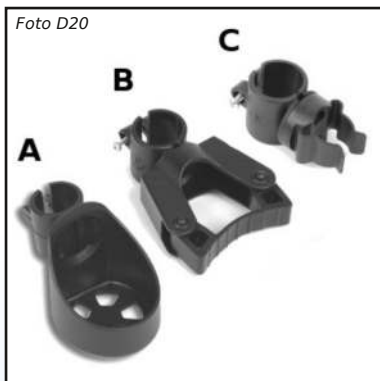

Cane holders (B and C) and cup (A)



Manual pump, (A) without or (B) with manometer



Mini air pump (A), fixing clip (B)



BOA lithium pump with bag and accessories



Car adapter for BOA pump



Brake greb for wheelchairs (A) or rollators (B)



Wheelchair standard brake (A), mounting clamp (C), lever extension (B) and Sport brake (D)



Wheelchair compact brake (closed / opened)



One-arm brake, available for assembly on left or right side

Foto DX1



Spoke guard transparent

Foto DX2



Spoke guard Bat

Foto DX3

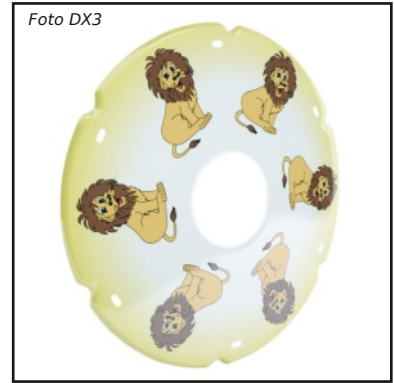

Spoke guard Lion

Foto DX4

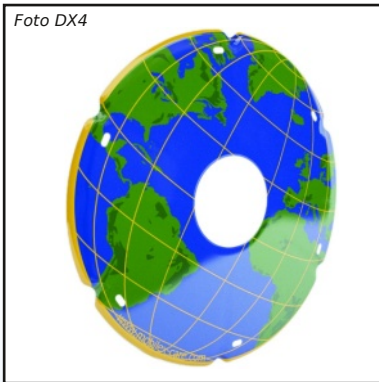

Spoke guard Earth

Foto DX5

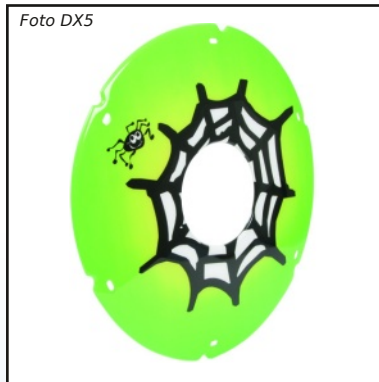

Spoke guard Spider

Foto DX6

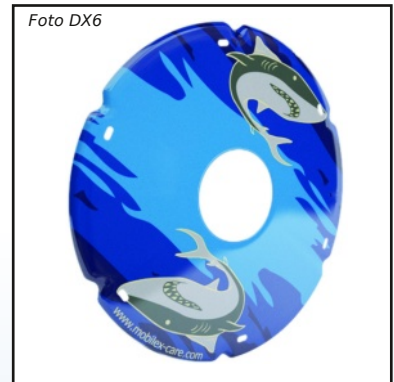

Spoke guard Shark

Foto DX7



Spoke guard Lightning

Foto DX8



Spoke guard Girl

Foto DX9



Spoke guard Horse

Foto DX10



Spoke guard Dragon

Foto DX11

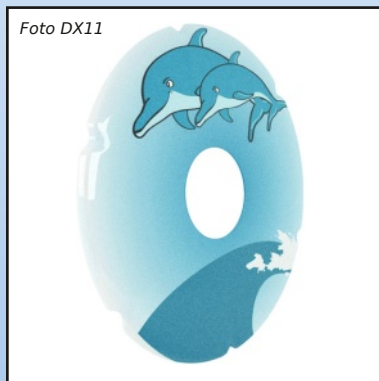

Spoke guard Dolphin

Foto DX12

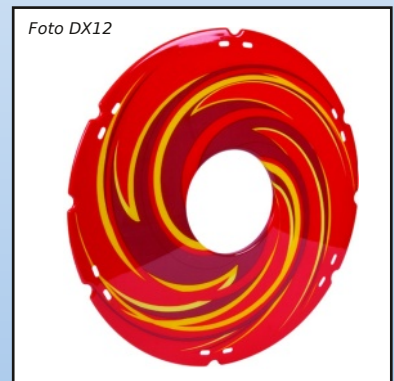

Spoke guard Fire

Foto DX13



Spoke guard Race

Foto DX14



Spoke guard Leaf

Foto DX15



Spoke guard Orange

Foto DX16



Spoke guard Flower

Foto DX17



Spoke guard Stallion

Foto DX18



Spoke guard Chameleon

Foto DX19

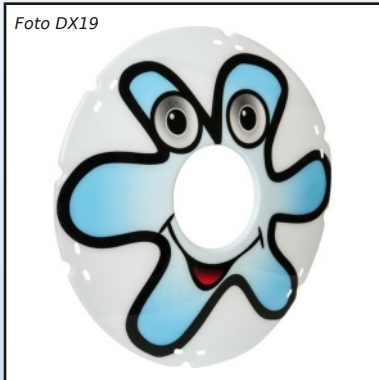

Spoke guard Bacteria

Foto DX20



Spoke guard Music

Foto DX21



Spoke guard Ghost

Foto DX22



Spoke guard Flamingo

Foto DX23



Spoke guard black

Foto D24



Box with 24 pcs. of 24" transparent spoke guards



Spoke guards with an individual customized design

Price list 07.2022

Spoke guards with custom design - What do Mobilex provide?

Mobilex provides personalized spoke guards in sizes 20", 22" and 24". Other dimensions depends on quantities and can be offered on request.

Mobilex Spoke guards are silk screen printed (serigraph).

Spoke guards are made of transparent PETG, are slightly curved and have cutouts for the 4 or 6 fastening segments of the pushrims. They are fastened with 6 clips on the spokes of the wheelchair wheel. The spoke guards have the required holes for the fastening clips, and the required clips are included. Shape and material correspond to the printed spoke guards from the Mobilex standard program.

Mobilex takes care of the whole process of the production, the printing and the delivery.

Spoke guards with custom design - What will we need from you?

Formats:

Under ideal circumstances you provide us with the desired drawing or logo already processed as vector graphics (.svg, .eps, .ai) because this enables us to make the layout easily.

If your graphical material is not available as vector graphics, we also accept .tif, .png or .jpg formats with a resolution of 300 DPI at a size of approximately: 200 x 200 mm.

Caution: In this case, layout processing charges may apply (see below)

Colours:

The colours should be defined with Pantone or HKS colour system codes. A printing film is created for each colour, then, colours are placed separately one after the other on the spokes guards. Because of this we need for each colour the exact indication of the Pantone or HKS colour codes.

Spoke guards with custom design - What does it cost?

Layout costs:

If we receive the finished layout as a vector graphic (see above) there are no additional design costs.

If a further processing is needed (as for pixel graphics) we charge a fee of 125.00 €

For a new designed layout (includes several layout proposals) we charge 250.00 €

Print costs net prices	1 colour	2 colours	3 colours	4 colours	5 colours	each additional colour
50 pcs.	on request	on request	on request	on request	on request	on request
100 pcs.	on request	on request	on request	on request	on request	on request
150 pcs.	on request	on request	on request	on request	on request	on request
200 pcs.	on request	on request	on request	on request	on request	on request
250 pcs.	on request	on request	on request	on request	on request	on request
300 pcs.	on request	on request	on request	on request	on request	on request

Attention! By default we print on a transparent background. Please clearly indicate a desired coloured background if desired. In this case also the background colour counts as one colour.

Number of pieces: we always try to produce the ordered number of pieces, but for production reasons it can come to a plus or minus of +/- 5%. These will also be billed.

Handles

Item nr.	Description	Foto	Price
293615	Handle M6 with 15 mm screw	D1A	9,50 €
293620	Handle M6 with 20 mm screw	D1A	9,50 €
293625	Handle M6 with 25 mm screw	D1A	9,50 €
293640	Handle M6 with 40 mm screw	D1A	10,50 €
293815	Handle M8 with 15 mm screw	D1A	9,50 €
293825	Handle M8 with 25 mm screw	D1A	9,50 €
293840	Handle M8 with 40 mm screw	D1A	10,50 €
294614	Handle M8 with 14 mm long femal thread	D1B	7,50 €
294820	Handle M8 with 20 mm long femal thread	D1B	7,50 €
291550	Star grip M5 with 50 mm screw	D1C	1,00 €
291615	Star grip M6 with 15 mm screw	D1C	1,00 €
291625	Star grip M6 with 25 mm screw	D1C	1,00 €
291640	Star grip M6 with 35 mm screw	D1C	1,00 €
291650	Star grip M6 with 45 mm screw	D1C	1,00 €
291815	Star grip M8 with 15 mm screw	D1C	1,00 €
291825	Star grip M8 with 25 mm screw	D1C	1,25 €
291840	Star grip M8 with 40 mm screw	D1C	1,25 €
292616	Star grip M6 with 16 mm inside thread	D1D	2,00 €
292816	Star grip M8 with threaded bush (16 mm depth)	D1D	2,00 €
290099	Box with 55 pcs. of clamping grips and finger screws	D2	256,00 €

Clips

Item nr.	Description	Foto	Price
295022	Clamp for ø22 mm tube with ø6 x 25 mm bolt, grey	D3	1,25 €
295025	Clamp for ø25 mm tube with ø6 x 28 mm bolt, grey	D3	1,25 €

Front forks

Item nr.	Description	Foto	Price
225001	Front fork, 120 x 39 with ø12 mm axle hole and 4 x ø8 mm holes	D8	24,50 €
225005	Front fork, 92 x 45 with ø12 mm axlehole and 2 x ø8 mm holes	D8	27,50 €
225006	Front fork, 120 x 45 with ø12 mm axle hole and 4 x ø8 mm holes	D8	31,00 €
225002	Front fork, 146 x 45 with ø12 mm axle hole and 6 x ø8 mm holes	D8	23,50 €
225004	Front fork, 180 x 45 with ø12 mm axle hole and 5 x ø8 mm holes	D8	26,50 €
225003	Front fork, 180 x 60 with ø12 mm axle hole and 5 x ø8 mm holes	D8	25,50 €
225102	Frontfork, black plastic 142 x 45 mm with M14 bolt and 2 ø8 mm holes	D7	30,00 €
225103	Front fork, black plastic, 142 x 60 mm with M14 bolt and 2 ø8 mm holes	D7	39,50 €
225202	DSF Dynamic suspension front fork, black 131 x 40,5 mm, with 3 ø8 mm holes	D5	116,00 €
225902	Threaded pin M12 x 1.25 x 78 mm for DSF Dynamic front forks	D8A	20,00 €

Anti-tip

Item nr.	Description	Foto	Price
271083	Anti-tip protector with 2 wheels, right/left for ø22/ø25 mm tubes	D25	25,50 €
271087	Anti-tip protector with 2 wheels, right/left for ø22/ø25 mm tubes (with vertical extra hole)	D25	26,50 €

Foam cover

Item nr.	Description	Foto	Price
226002	Foam cover ø18/ø36 x 660 mm for ø20 mm tube	D10B	7,50 €
226001	Foam cover ø20/ø36 x 660 for ø22 mm tube	D10B	7,50 €
226003	Foam cover ø22/ø38 x 660 mm for 24 mm tube, black	D10B	7,50 €
226005	Foam cover smooth, ø23/ø36 x 660 for ø25 mm tube	D10A	7,50 €
226006	Foam cover smooth, ø26/ø36 x 660 for ø28 mm tube	D10A	7,50 €

Grips

Item nr.	Description	Foto	Price
226010	Handgrip smooth, ø19 mm, L=110 mm	D13A	2,25 €
226024	Handgrip smooth, ø22 mm, L=110 mm	D13A	2,25 €
226012	Hand grip smooth, ø22 mm, L=140 mm	D13A	3,75 €
226027	Handgrip GRIP 45A, black TPE, length 120 mm, for ø22 mm tube	D13B	5,75 €
226015	Foam grip from black soft foam, ø22 mm, L=130 mm with end cap	D13C	2,25 €
226011	Handgrip with finger grip, ø22 mm, L=105 mm	D14A	1,00 €
226025	Handgrip with finger grip, ø22 mm, L=125 mm	D14B	6,00 €
226026	Handgrip with finger grip, ø25 mm, L=125 mm	D14B	6,00 €
226020	Handgrip with finger grip and reflex, ø22 mm	D14C	4,00 €
226013	Anatomical hand grip Cobra, ø22 mm, L=140 mm, left side	D15	2,50 €
226014	Anatomical hand grip Cobra, ø22 mm, L=140 mm, right side	D15	2,50 €
226017	Anatomical handgrip Cobra, through-hole ø22 mm, L=140 mm, left side	D15	4,25 €
226018	Anatomical handgrip Cobra, through-hole ø22 mm, L=140 mm, right.	D15	4,25 €

Rubber capsules

Item nr.	Description	Foto	Price
226119	Rubber shoe for bath chair, 19 mm, grey	D12B	1,00 €
226122	Rubber shoe for shower stool, 22 mm, grey	D12B	1,00 €
226121	Rubber shoe for shower stool, 22 mm, grey, round model	D12B	1,00 €
226125	Rubber shoe for shower stool, 25 mm, grey	D12B	1,00 €
226216	Rubber tips for crutch 15/16 mm, grey	D12A	1,25 €
226219	Rubber tips for crutch 18/19 mm, grey	D12A	1,25 €
226222	Rubber tips for crutch 22 mm, grey	D12A	2,00 €
226225	Rubber tips for crutch 25 mm, grey	D12A	2,50 €

Cane holders

Item nr.	Description	Foto	Price
233001	Cane holder for ø22 mm tube	D20B	9,50 €
233002	Cane holder for ø25 mm tube	D20B	9,50 €
233023	Cane holder for ø27 mm tube	D20B	9,50 €
233005	Cane clip for ø22 mm tube	D20C	8,50 €
233006	Cane clip for ø25 mm tube	D20C	8,50 €
233003	Cup for cane holder for ø22 mm tube	D20A	13,00 €
233004	Cup for cane holder for ø25 mm tube	D20A	13,00 €
233024	Cup for cane holder for ø27 mm tube	D20A	13,00 €

Silicone covers

Item nr.	Description	Foto	Price
221201	20" Siliconecover for pushrims of ø435-450 mm, smooth	D9A	42,50 €
221202	20" Siliconecover for pushrims of ø435-450 mm, grooved	D9B	47,00 €
221221	22" Siliconecover for pushrims of ø485-500 mm, smooth	D9A	42,50 €
221223	22" Siliconecover for pushrims of ø500-515 mm, smooth	D9A	42,50 €
221222	22" Siliconecover for pushrims of ø485-500 mm, grooved	D9B	49,00 €
221241	24" Siliconecover for pushrims of ø525-540 mm, smooth	D9A	39,50 €
221242	24" Siliconecover for pushrims of ø525-540 mm, grooved	D9B	51,00 €
221261	26" Siliconecover for pushrims of ø575-590 mm, smooth	D9A	51,00 €
221262	26" Siliconecover for pushrims of ø575-590 mm, grooved	D9B	58,00 €

Pumps

Item nr.	Description	Foto	Price
260020	BOA high pressure air pump incl. 50 cm hose with snap lock	D19	89,00 €
260024	12V charger for BOA pump	D16A	19,00 €
260025	0,5 m extension hose with clip for BOA pump	D16B	15,00 €
260014	Foot pump with car/bicycle valve	D17A	19,00 €
260015	Foot pump with manometer	D17B	25,50 €
260016	Pump black, L=240 mm	D18A	8,00 €
260012	Clips for handpump, ø25 mm	D18B	2,75 €
260017	Schwalbe Airmax Pro manometer	B12I	23,50 €

Brakes

Item nr.	Description	Foto	Price
209065	Standard tyre brake - right	D22A	20,00 €
209066	Standard tyre brake - left	D22A	20,00 €
209068	Brake handle extension for standard brake that can be bent down, 10 cm long	D22B	6,50 €
20906G	Rubber grip for standard brake	D22A	1,00 €
209063	Sports brake - side A (right)	D22D	25,50 €
209064	Sports brake - side B (left)	D22D	25,50 €
20906M	Compact brake right side	D23	31,00 €
20906J	Compact brake left side	D23	31,00 €
209061	One-arm brake, set with 2 brakes, used from right	D24	138,00 €
209062	One-arm brake, set with 2 brakes, used from left	D24	138,00 €
20906F	Cabel for one arm brake	D24	26,50 €
209090	Brake handle, black plastic for 22 mm tubes	D21A	19,00 €
209091	Brake handle, black plastic for rollator for ø22 mm pipe (for Impala Rollator)	D21B	10,50 €
209067	Fitting clamp for brake ø22 mm tube	D22C	8,50 €
209060	Fitting clamp for brake ø25 mm tube	D22C	7,50 €
20906E	Fitting clamp for brake ø30 mm tube	D22C	13,00 €

Mobilex A/S - Price list

All prices are per pcs. and in EUR.

07.2022

Leaflet D-DX

Various

Item nr.	Description	Foto	Price
233012	Safety belt 150 cm	D6A	14,00 €
233013	Safety belt 200 cm for fitting around the wheel chair	D6B	15,00 €
233014	Safety belt 130 cm with steel fitting bracket	D6C	18,00 €
233009	Crutch holder from steel	D11A	48,00 €
233008	Universal adapter for 233009 crutch holder	D11B	22,50 €
233010	Adapter for 233009 for Minicrosser	D11C	23,50 €
233051	Calf band, height 5 cm, universal, for seat widths from 40-50 cm	D4B	4,25 €
233054	Calfband, height 9 cm, universal, for seat widths from 40-50 cm	D4A	7,50 €
233055	Heel band, height 5 cm, L=48 cm		6,50 €

Spoke guards

Item nr.	Description	Foto	Price
220200	20" Spokeguard, transparent, for 4/6 point fitting	DX1	32,00 €
220203	20" Spokeguard, Bat, for 4/6 point fitting	DX2	70,00 €
22020D	20" Spokeprotectors, Lion, for 4/6 point fitting	DX3	70,00 €
220205	20" Spokeguard, Spider, for 4/6 point fitting	DX5	70,00 €
220209	20" Spokeguard, Girl, for 4/6 point fitting	DX8	70,00 €
22020B	20" Spokeprotectors, Dolphin, for 4/6 point fitting	DX11	70,00 €

220220	22" Spokeguard, transparent, for 4/6 point fitting	DX1	34,00 €
220223	22" Spokeguard, Bat, for 4/6 point fitting	DX2	70,00 €
22022D	22" Spokeprotectors, Lion, for 4/6 point fitting	DX3	70,00 €
22022E	22" Spokeprotectors, Earth, for 4/6 point fitting	DX4	70,00 €
220225	22" Spokeguard, Spider, for 4/6 point fitting	DX5	70,00 €
22022C	22" Spokeprotectors, Shark, for 4/6 point fitting	DX6	70,00 €
220227	22" Spokeguard, Lightning, for 4/6 point fitting	DX7	70,00 €
220229	22" Spokeguard, Girl, for 4/6 point fitting	DX8	70,00 €
220224	22" Spokeguard, Horse, for 4/6 point fitting	DX9	70,00 €
22022A	22" Spokeprotectors, Dragon, for 4/6 point fitting	DX10	70,00 €
22022B	22" Spokeprotectors, Dolphin, for 4/6 point fitting	DX11	70,00 €
22022F	22" Spokeprotectors, Fire, for 4/6 point fitting	DX12	70,00 €
22022K	22" Spokeprotectors, Race, for 4/6 point fitting	DX13	70,00 €
22022J	22" Spokeprotectors, Flower, for 4/6 point fitting	DX16	70,00 €
22022H	22" Spokeprotectors, Stallion, for 4/6 point fitting	DX17	70,00 €
22022P	22" Spokeprotectors, Bacteria, for 4/6 point fitting	DX19	70,00 €
22022N	22" Spokeprotectors, Ghost,, for 4/6 point fitting	DX21	70,00 €

220240	24" Spokeguard, transparent, for 4/6 point fitting	DX1	30,00 €
220243	24" Spokeguard, Bat, for 4/6 point fitting	DX2	70,00 €
22024D	24" Spokeprotectors, Lion, for 4/6 point fitting	DX3	70,00 €
22024E	24" Spokeprotectors, Earth, for 4/6 point fitting	DX4	70,00 €
220245	24" Spokeguard, Spider, for 4/6 point fitting	DX5	70,00 €
22024C	24" Spokeprotectors, Shark, for 4/6 point fitting	DX6	70,00 €
220247	24" Spokeguard, Lightning, for 4/6 point fitting	DX7	70,00 €
220249	24" Spokeguard, Girl, for 4/6 point fitting	DX8	70,00 €
220248	24" Spokeguard, Horse, for 4/6 point fitting	DX9	70,00 €
22024A	24" Spokeprotectors, Dragon, for 4/6 point fitting	DX10	70,00 €
22024B	24" Spokeprotectors, Dolphin, for 4/6 point fitting	DX11	70,00 €
22024F	24" Spokeprotectors, Fire, for 4/6 point fitting	DX12	70,00 €
22024K	24" Spokeprotectors, Race, for 4/6 point fitting	DX13	70,00 €
22024G	24" Spokeprotectors, Leaf, for 4/6 point fitting	DX14	70,00 €
22024L	24" Spokeprotectors, Orange, for 4/6 point fitting	DX15	70,00 €
22024J	24" Spokeprotectors, Flower, for 4/6 point fitting	DX16	70,00 €
22024H	24" Spokeprotectors, Stallion, for 4/6 point fitting	DX17	70,00 €
22024Q	24" Spokeprotectors, Chameleon, for 4/6 point fitting	DX18	70,00 €
22024P	24" Spokeprotectors, Bacteria, for 4/6 point fitting	DX19	70,00 €
22024M	24" Spokeprotectors, Music, for 4/6 point fitting	DX20	70,00 €
22024N	24" Spokeprotectors, Ghost,, for 4/6 point fitting	DX21	70,00 €
22024T	24" spoke guard, Flamingo for 4/6 fittings	DX22	70,00 €
22024S	24" Spokeprotectors, black, for 4/6 point fitting	DX23	58,00 €

220261	26" Spokeguard, transparent, for 6 point fitting	DX1	58,00 €
--------	--	-----	---------

22024X	24" Spokeguard, transparent, for 4/6 point fitting, box with 24 pcs.	DX24	618,00 €
--------	--	------	----------

220097	Clips for spoke protectors, bag with 6 pcs.		1,00 €
--------	---	--	--------

MOULDED PU PARTS

MOULDED PU PARTS



Leaflet DZ

Armrests, headrests, side supports and leg spreader

Foto DZ1



PU armrest 12 x 35 cm.
hole distance 15 cm

Foto DZ2



PU calf support 14 x 16 cm

Foto DZ3



Armrest pad, PU, available in
different sizes

Foto DZ4



Upholstered armrest with plastic
bottom shell, available in different
sizes

Foto DZ5



Armrest for pipe fitting e.g. for
Invacare wheelchairs

Foto DZ6



Armrest for plate fitting e.g. for
Invacare wheelchairs

Foto DZ7



Armrest made of PU integral foam
with curved front

Foto DZ8



Armrest with adjustable holes
for pipe fitting

Foto DZ9



Armrest with adjustable holes
for plate fitting

Foto DZ10



Arm pad PU for arthritis rollator

Foto DZ11



Leg spreader made of PU
integral foam

Foto DZ12



Side support with universal
holder for Ø 25 mm pipes

Foto DZ20



Arm shell made of PU integral foam for hemiplegics

Foto DZ21



Intermediate piece for the extension of the hemiplegic arm shell

Foto DZ22



Hand rest with anatomical grip. Left or right.

Foto DZ30



Headrest shell

Foto DZ31



PU headrest with adjustable retaining fingers

Foto DZ35



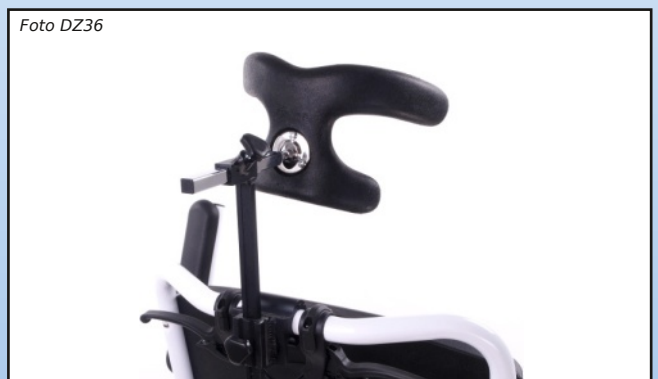

Complete headrest with bracket mountable e.g. on the tubes of the push bars of a wheelchair

Foto DZ36

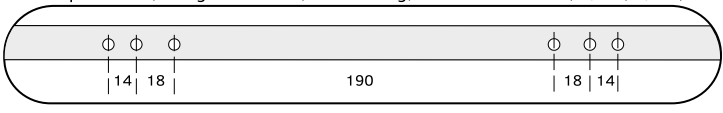
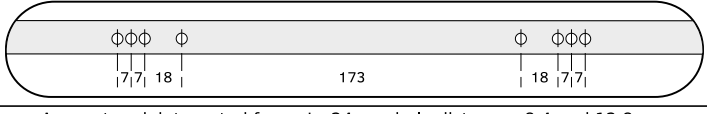
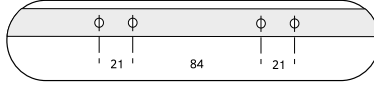
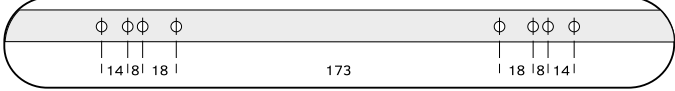
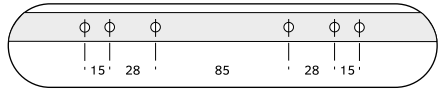
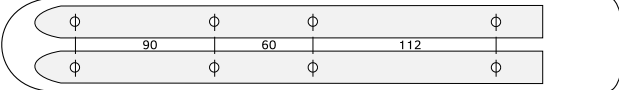

Complete headrest with bracket mountable e.g. on the push bar of a commode shower wheelchair

Armrests

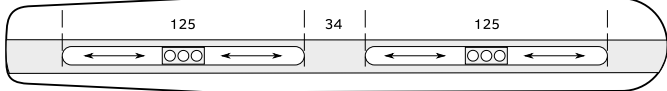
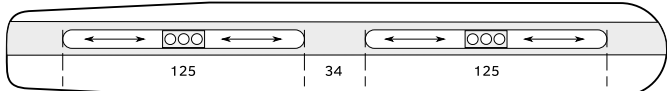
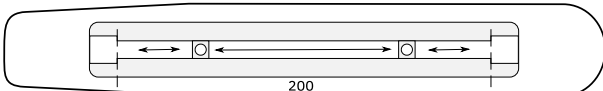
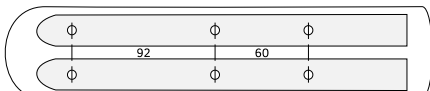
Item nr.	Description und Lochabstände	Foto	Price
233037	Armrest pad black, integrated foam, 37 cm long, hole distances 19,1 / 22,7 / 25,5 cm 	DZ3	11,50 €
233031	Armrest pad, integrated foam, L=37 cm, hole distances 22,7 og 24 cm 	DZ3	10,50 €
233032	Armrest pad, integrated foam, L=24 cm, hole distances 8,4 und 12,8 cm 	DZ3	10,50 €
233033	Armrest pad, with plastic base, 37 cm long, hole distances 17,3 / 21 / 22,7 / 25,3 cm 	DZ4	8,50 €
233034	Armrest pad black, with plastic base, 26 cm long, hole spacing 8,4 / 14 / 17,2 cm 	DZ4	7,50 €
233035	Armrest pad, Invacare type, for tubes, L=38 cm, hole distances 9 / 11,2 / 15 / 17,2 / 26 cm 	DZ5	15,00 €
233036	Armrest pad black, Invacare type, for fitting plate, L=38 cm 	DZ6	15,00 €
233045	Armrest pad with curved front, black integrated foam, 30 x 5 cm, hole distances 17,2 cm 	DZ7	13,00 €
233039	Armrest pad black, integrated foam, 35 cm long, with adjustable hole distances, left 	DZ8	20,00 €
233040	Armrest pad black, integrated foam, 35 cm long, with adjustable hole distances, right 	DZ8	20,00 €
233043	Armrest pad black, integrated foam, 33 cm long, with adjustable hole distances 	DZ9	21,50 €
233048	Armrest pad Invacare type, for round tubes, L=27,5 cm, hole distances 90, 92 and 151 mm 	DZ5	25,50 €

Forearm pads

Item nr.	Description und Lochabstände	Foto	Price
233038	Armrest pad black, integrated foam, 12 x 35 cm, distance between holes 15 cm	DZ1	34,00 €
312333	Armpad PU for arthritis rollator	DZ10	42,50 €

Forearm pads for hemiplegics

Item nr.	Description	Foto	Price
233050	Underarmpad black, integral foam, 26 cm long, with adjustable hole distances	DZ20	75,00 €
233056	Handle for underarmpad, integral foam, adjust. hole distances, right side	DZ22	64,00 €
233057	Handle for underarmpad, integral foam, adjust. hole distances, left side	DZ22	64,00 €
233053	Extender for underarmpad black, integrated foam, 7 cm long, with adjustable hole distances	DZ21	21,50 €

Headrests

Item nr.	Description	Foto	Price
233046	PU head rest, black plastic base, 25 cm long and 9 cm wide	DZ30	23,50 €
302141	Headrest from PU	OY4A	68,00 €

271075	Head support inkl. fixationsystem for Dolphin/Barracuda	DZ35	202,00 €
D2101	Complete head support for Kakadu 302024 and 302025	DZ36	149,00 €

Other PU moulded parts

Item nr.	Description	Foto	Price
233041	Calf support, black, 14 x 16 cm	DZ2	21,50 €
233047	Leg spreader wedge, black PU foam, 13 x 8 cm	DZ11	13,50 €

30212P	Side support for shower chair - 10 x 14 cm - left side	OY11	55,00 €
30212Q	Side support for shower chair - 14 x 20 cm - left side	OY11	60,00 €
30212R	Side support for shower chair - 10 x 14 cm - right side	OY11	55,00 €
30212S	Side support for shower chair - 14 x 20 cm - right side	OY11	60,00 €

RAISED TOILET SEATS

RAISED TOILET SEATS



Leaflet E

Raised toilet seats and soft toilet seat covers

Detachable toilet seats



Raised toilet seat without lid



Raised toilet seat with lid

The ergonomic raised toilet seat is available in heights of 5, 10 or 15 cm.

Since no edges are present, where dirt can accumulate, the raised toilet seat is easy to clean. It is waterproof and can be sterilized at 85°C.

The toilet seat opening is 220 mm wide and 270 mm deep.

The maximum load is 190 kg.

Fixed raised toilet seat



Fixed toilet seat

Fixed 10 cm toilet seat

Fixed toilet seat (E3) with lid. New design with new developed fitting system in aluminium. The Toilet seat is easy to fit in the holes where the original seat was fitted.



Fitting system

The armrests can be lifted and are also detachable.

The opening is 220 mm x 270 mm (W x D)

Max. load is 120 kg



Höhenverstellbare Toilettensitz Erhöhung



Detail Höhenverstellung

Height adjustable fixed toilet seats

The height adjustable toilet seat is made from non-corroding materials and is easy to clean. Can be fitted on all standards toilets and has lift-up and detachable armrests that can be taken off in either side.

Adjustable to 3 heights:
60 mm, 100 mm and 150 mm

Total width with armrests: 500 mm

Max. load is 120 kg

Soft toilet seat cover



Black soft cover



Whites soft cover

The polyurethane covers (E5) fit standard toilet seats and can be cleaned with hot water and neutral soap. Available in black and white.

Dimensions: 37.5 x 43.5 cm (W x D)

The toilet opening is 22 x 27.5 cm (W x D)

Thickness 4 cm

Spare parts



Lock device for 301101-06



Fixating kit for 301702

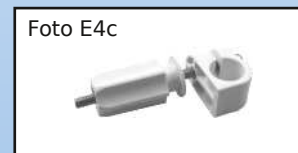

Fixating kit for 301703

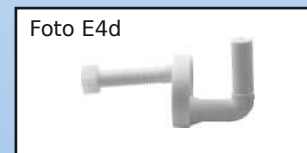

Fixating kit for 301701

Raised toilet seats

Item nr.	Description	Foto	VE *	Price
301102	Raised toilet seat, without lid, 5 cm	E1	6 pcs.	34,00 €
301104	Raised toilet seat, without lid, 10 cm	E1	6 pcs.	38,50 €
301106	Raised toilet seat, without lid, 15 cm	E1	6 pcs.	44,50 €
301101	Raised toilet seat, with lid, 5 cm	E2	6 pcs.	38,50 €
301103	Raised toilet seat, with lid, 10 cm	E2	6 pcs.	42,50 €
301105	Raised toilet seat, with lid, 15 cm	E2	6 pcs.	49,00 €
301702	Fixed toiletseat with lift-up armrests	E3A	1 pc.	147,00 €
301703	Fixed toiletseat, height adjustable, with lift-up armrests	E4A	1 ps.	117,00 €
301201	Soft toilet cover, black	E5A	1 pc.	58,00 €
301204	Soft toilet cover, white	E5B	1 pc.	58,00 €

* PU = pieces per packing unit

Spare parts for raised toilet seats

Item nr.	Description	Foto	Price
301151	Locking device for raised toilet seat		2,50 €
301156	Fixation kit for fixed raised toiletseat 301702		11,50 €
301155	Fixation kit for fixed raised toiletseat 301701/03		10,50 €
301711	Plastic part for lid on 301701		2,25 €
301712	Complete lid for 301702		14,00 €

Dimensions of the Mobilex raised toilet seats

Dim.	301101-06	301702	301703
D	40 cm	46 cm	47,5 cm
d	27 cm	29 cm	27 cm
B	36 cm	40 cm	42,5 cm
b	22 cm	24 cm	22 cm
F	---	10 - 16 cm	3,5 - 33 cm
c	5 cm	10,5 cm	9 cm
e	---	3 cm	0 oder 4 cm
G*	31 - 38,5 cm	---	---

a	---	55 cm	51 cm
A	---	65 cm	59 cm

* G is the internal distance between the jaws of the fastening clamps

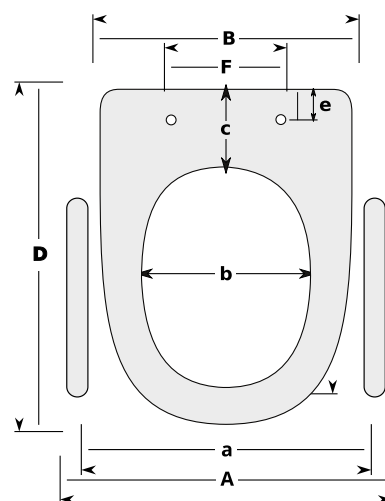

PRESSURE RELIEVING PRESSURE RELIEVING MATTRESSES MATTRESSES



Leaflet G

Pressure-relieving mattresses

Low-cost model type B01

Foto G1

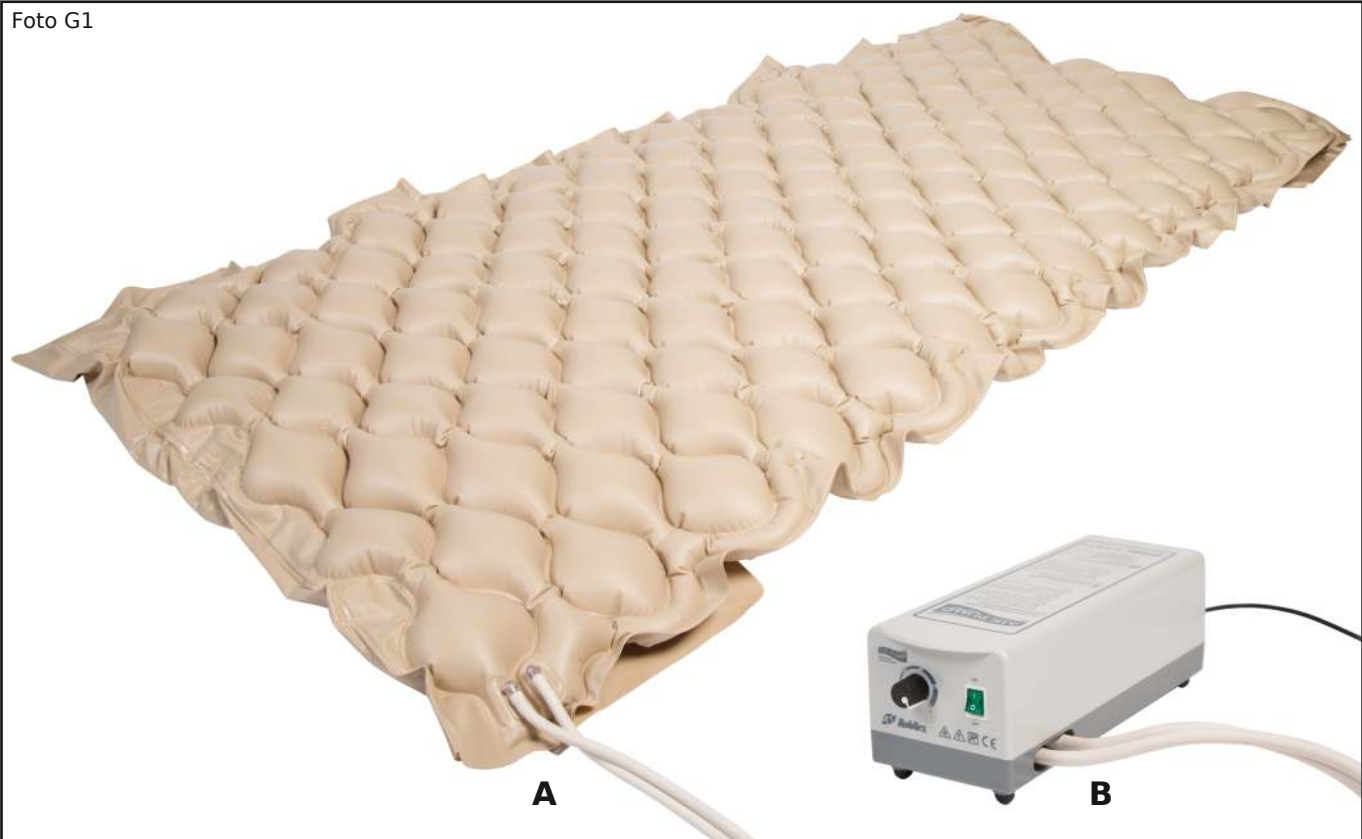

Pressure-relieving mattress Type B01 with pump P05

Alternating pressure bubble mattress with double air chamber system. The cells are filled and deflated in an alternating 6-minute cycle. The air pressure is adjustable according to the user's weight.

The mattress is made of antibacterial and waterproof material and is used for the prevention (prophylaxis) of decubitus wounds (decubitus up to stage I).

The pump (compressor) is easy to adjust, is insensitive to dust and can be fixed to the bed frame.

The mattress is supplied complete with the adjustable pump.

Foto G1c



Repair kit for mattress B01

Technical data	Mattress B01
<i>Dimensions of the mattress</i>	6 x 90 x 200 cm (H x W x L)
<i>Min/max load</i>	20 / 130 kg
<i>Material of the ARIA mattress</i>	PVC

Technical data	Compressor (pump) P05
<i>Cycle time</i>	6 min.
<i>Air flow</i>	6-7 lt/min.
<i>Pressure range</i>	70~130 mm Hg

Pressure-relieving mattresses

Item nr.	Description	Foto	Price
270016	Pressure relieving mattress B01, 6 cm x 90 cm x 200 cm, incl. P05 pump with regulation	G1	88,00 €

Spare parts for pressure-relieving mattresses

Item nr.	Description	Foto	Price
270017	Pressure relieving mattress B01, 6 cm x 90 cm x 200 cm	G1A	29,00 €
270018	Pump for B01 mattress	G1B	69,00 €
270019	Repair kit for pressure relieving mattress B01 (270017)	G1C	7,50 €

WHEELCHAIRS **WHEELCHAIRS**



Leaflet H/HY

Aluminium wheelchairs
Dolphin and Barracuda

The Mobilex Dolphin lightweight wheelchair has a frame made of silver-coloured aluminium. The seat depth can be adjusted on the wheelchair (from 42 cm to 48 cm). The 24" rear wheels are equipped with quick-release axles, the wheelbase and the seat height are also adjustable. The front wheel forks are also attached with quick-release axles. The height of the fold-up armrests can be easily adjusted by means of a button fastener and without tools. The height of the push handles can also be adjusted. The footrests are height adjustable. Angle-adjustable footrests are available as an option. The wheelchair is available in different sizes and is equipped with puncture-proof tyres as standard. A standard seat cushion, the depth of which can be adjusted to the seat, is also included in the scope of delivery.

Dolphin	271340	271344	271348	271351	271354	271357
Seat-width	40 cm	44 cm	48 cm	51 cm	54 cm	57 cm
Seat-depth adjustable	42 cm, 44 cm, 46 cm, 48 cm					
Seat-height min./max.*	45 – 52,5 cm in steps of 1,5 cm					
Total width	60,30 cm	64,30 cm	68,30 cm	71,30 cm	74,30 cm	77,30 cm
Weight	15,60 kg	15,90 kg	16,20 kg	16,75 kg	19,40 kg	22,64 kg
Tyres front/back	PU/PU	PU/PU	PU/PU	PU/PU	PU/PU	PU/PU
Max. user weight	150 kg	150 kg	150 kg	150 kg	200 kg	200 kg

Difference w/ drumbrakes	271440	271444	271448	271451	271454	271457
Weight	16,10 kg	16,40 kg	16,60 kg	17,25 kg	20,10 kg	23,14 kg

* **Attention!** When adjusting the seat height, the front wheels must be adapted too!



Seat width 40, 44, 48, 51, 54, 57 cm
Seat depth adjustable from 42 to 48 cm



Height adjustable and foldable armrests, height adjustable handles

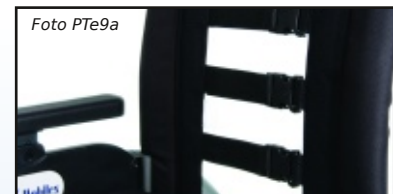

Velcro-back for wheelchair (accessory)

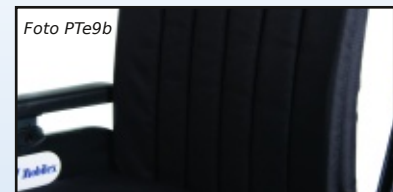

Flip-cover for Velcro-back (accessory)



The wheelchair is also available with drum brakes (load capacity max. 150 kg)



Adjustable seat-depth and seat-height



Angle and height adjustable footrest (accessory)



Anti-Tip (accessory)



4" Transfer wheel (accessory)



Tilting pedal (accessory)

Dolphin wheelchair with the following standard equipment:

- Anti-incontinence seat cushion, adjustable to the seat depth
- Seat depth adjustable
- Height adjustable push handles
- Height-adjustable and foldable armrests
- Drive wheels with puncture-proof tyres
- Removable axles on rear and front wheels
- Tipping aid

Dolphin wheelchair

Item nr.	Description	Foto	Price
271340	Dolphin aluminium wheelchair, seat width 40 cm	H1A	596,00 €
271344	Dolphin aluminium wheelchair, seat width 44 cm	H1A	596,00 €
271348	Dolphin aluminium wheelchair, seat width 48 cm	H1A	596,00 €
271351	Dolphin wheelchair, Aluminium, SW. 51 cm, SD. 42-48 cm, silver metal with standard wheels	H1A	618,00 €
271354	Dolphin aluminium wheelchair, seat width 54 cm	H1A	852,00 €
271357	Dolphin aluminium wheelchair, seat width 57 cm	H1A	852,00 €

271440	Dolphin aluminium wheelchair with drum brakes, seat width 40 cm	H1D	703,00 €
271444	Dolphin aluminium wheelchair with drum brakes, seat width 44 cm	H1D	703,00 €
271448	Dolphin aluminium wheelchair with drum brakes, seat width 48 cm	H1D	703,00 €
271451	Dolphin aluminium wheelchair with drum brakes, seat width 51cm	H1D	735,00 €
271454	Dolphin aluminium wheelchair with drum brakes, seat width 54 cm	H1D	1.054,00 €
271457	Dolphin aluminium wheelchair with drum brakes, seat width 57 cm	H1D	1.054,00 €

Accessories for Dolphin wheelchairs

Item nr.	Description	Foto	Price
271082	Anti-tip protector with one wheel, right/left for Dolphin/Barraduda	H1H	46,00 €
271085	Transit wheels for Dolphin/Barracuda, pairs	H1I	81,00 €
271086	Steppedal for Dolphin/Barracuda	H1J	15,00 €

271A81	Height and angle adjustable leg rest for Dolphin/Barracuda, SW 40 cm, left	H1F	256,00 €
271A82	Height and angle adjustable leg rest for Dolphin/Barracuda, SW 40 cm, right	H1F	256,00 €
271A83	Height and angle adjustable leg rest for Dolphin/Barracuda, SW 44 cm, left	H1F	256,00 €
271A84	Height and angle adjustable leg rest for Dolphin/Barracuda, SW 44 cm, right	H1F	256,00 €
271A85	Height and angle adjustable leg rest for Dolphin/Barracuda SW, 48 cm, left	H1F	256,00 €
271A86	Height and angle adjustable leg rest for Dolphin/Barracuda, SW 48 cm, right	H1F	256,00 €
271A87	Height and angle adjustable leg rest for Dolphin/Barracuda, SW 51-57 cm, left	H1F	256,00 €
271A88	Height and angle adjustable leg rest for Dolphin/Barracuda, SW 51-57 cm, right	H1F	256,00 €

271075	Head support inkl. fixationsystem for Dolphin/Barracuda	DZ35	202,00 €
--------	---	------	----------

27840H	Seat cushion for Dolphin, 40 x 42-48 x 5 cm (W x D x H)	P3B	44,50 €
27842H	Seat cushion for Dolphin, 42 x 42-48 x 5 cm (W x D x H)	P3B	44,50 €
27844H	Seat cushion for Dolphin, 44 x 42-48 x 5 cm (W x D x H)	P3B	42,50 €
27848H	Seat cushion for Dolphin, 48 x 42-48 x 5 cm (W x D x H)	P3B	49,00 €
27851H	Seat cushion for Dolphin, 51 x 42-48 x 5 cm (W x D x H)	P3B	53,00 €
27854H	Seat cushion for Dolphin, 54 x 42-48 x 5 cm (W x D x H)	P3B	55,00 €
27857H	Seat cushion for Dolphin, 57 x 42-48 x 5 cm (W x D x H)	P3B	58,00 €

271645	Flipback for wheel chair, width 40 cm	PTE9B	47,00 €
271646	Flipback for wheelchair, width 44 cm	PTE9B	47,00 €
271647	Flipback for wheelchair, width 48 cm	PTE9B	51,00 €
271648	Flipback for wheelchair, width 51 cm	PTE9B	50,00 €

271649	Velcroback for wheelchair, SW: 40 - 44 cm	PTE9A	51,00 €
271650	Velcroback for wheelchair, SW: 48 - 51 cm	PTE9A	53,00 €

Mobilex A/S - Price list

All prices are per pcs. and in EUR.

07.2022

Leaflet H

A	40 cm	44 cm	48 cm	51 - 57 cm
Left	271A61	271A63	271A65	271A67
Rigth	271A62	271A64	271A66	271A68

Mobilex A/S DK-8660 Skanderborg		Material	
DESIGN	NAME	DATE	SIGNATURE
APPROVED			
SCALE			
DESIGNATION			
		APPLY TO TYPE	DWG NO:
		EDITION:	POS:
			DWG NO:

Spare parts for Dolphin and Barracuda wheelchairs

Item nr.	Description	Price
271627	Arm rest complete with arm rest pad, left	84,00 €
271628	Arm rest complete with arm rest pad, right	84,00 €
271601	Hand grip for pushhandle, black rubber	2,25 €
271603	Handle for fixation of push handle	15,00 €
271A61	Legsupport, complete for Dolphin for SW 40 cm, left	99,00 €
271A62	Legsupport, complete for Dolphin for SW 40 cm, right	99,00 €
271A63	Legsupport, complete for Dolphin for SW 44 cm, left	99,00 €
271A64	Legsupport, complete for Dolphin for SW 44 cm, right	99,00 €
271A65	Legsupport, complete for Dolphin for SW 48 cm, left	99,00 €
271A66	Legsupport, complete for Dolphin for SW 48 cm, right	99,00 €
271A67	Legsupport, complete for Dolphin for SW 51 cm, left	99,00 €
271A68	Legsupport, complete for Dolphin for SW 51 cm, right	99,00 €
271605	PU Arm rest pad 325 mm long, for Dolphin/Barracuda	46,00 €
271602	Push handle incl. hand grip and handle	21,50 €
271604	Push handle incl. hand grip and handle for chairs with drumbrake wheels	26,50 €

Standard spare parts

Item nr.	Description	Price
21520F	20" wheel, black hub ø12 x 53 mm, PU tyre 1 3/8", silver aluminium pushrim	72,00 €
21522F	22" wheel, black, ø12 x 53 mm hub, PU tyre 1 3/8", silver aluminium pushrim	77,00 €
21524F	24" wheel, black, ø12 x 53 mm hub, PU tyre 1 3/8", silver aluminium pushrim	77,00 €
202083	8" Polyurethane wheel, 200 x 45 mm, with distance bushes for 60 mm fork	29,00 €
209060	Fitting clamp for brake ø25 mm tube	7,50 €
209066	Standard tyre brake - left	20,00 €
209065	Standard tyre brake - right	20,00 €

Aluminium Lightweight Wheelchair "Barracuda" with adjustable backrest (until 30°). The inclination of the back is easy to do also by the wheelchair user himself, by pressing the buttons on the backside of the backrest. The wheelchair has a frame made of silver coloured aluminium. The 24" rear wheels are equipped with quick release axles, and the seat height is also adjustable. The seat depth can be adjusted from 42-48 cm. The armrests are easily adjustable in height and can be folded up to ease access. The push handles are adjustable in height. The footrests are height adjustable. Angle adjustable footrests are optional. Anti-tip and transfer wheels are available as accessories. The wheelchair is available in different sizes (see table below) and is fitted with puncture-proof tyres. A standard seat cushion that can be adjusted to the depth of the seat is also included.

Barracuda	271840	271844	271848	271851
Seat-width	40 cm	44 cm	48 cm	51 cm
Seat-depth adjustable	42 cm, 44 cm, 46 cm, 48 cm			
Seat height adjust. min./max. *	45 - 52,5 cm in steps of 1,5 cm			
Total width	60,30 cm	64,30 cm	68,30 cm	71,30 cm
Backrest inclination	from 0 to 30 degrees			
Weight / with drum brakes	20,2 kg	20,5 kg	20,8 kg	21,35 kg
Max. user weight	120 kg			

Difference w/ drumbrakes	272040	272044	272048	272051
Total width	20,7 kg	21 kg	21,30 kg	21,85 kg

* **Attention!** When adjusting the seat height, the front wheels must be adapted too!



Seat width 40, 44, 48, 51, 54, 57 cm, Seat depth adjustable 42 - 48 cm. Back tiltable 0-30°



Adjustable seat-depth and seat-height



Detail of the release button of the tilting mechanism



Height adjustable armrests, can be folded up, height adjustable push-handles



Optional headrest



Angle and height adjustable footrest (accessory)



Anti-Tip (accessory)



4" Transfer wheel (accessory)



Tilting pedal (accessory)

Attention! The adjustable backrest of the Barracuda wheelchair increases the risk of tipping over. Therefore, we strongly recommend the use of the Anti-Tip!

Barracuda wheelchair

Item nr.	Description	Foto	Price
271840	Barracuda aluminium wheelchair with adjustable back, SW. 40 cm	HY1A	796,00 €
271844	Barracuda aluminium wheelchair with adjustable back, SW. 44 cm	HY1A	796,00 €
271848	Barracuda aluminium wheelchair with adjustable back, SW. 48 cm	HY1A	796,00 €
271851	Barracuda aluminium wheelchair with adjustable back, SW. 51 cm	HY1A	841,00 €

272040	Barracuda wheelchair with adjustable back, Aluminium, SW. 40 cm, with drum brakes		982,00 €
272044	Barracuda wheelchair with adjustable back, Aluminium, SW. 44 cm, with drum brakes		982,00 €
272048	Barracuda wheelchair with adjustable back, Aluminium, SW. 48 cm, with drum brakes		982,00 €
272051	Barracuda wheelchair with adjustable back, Aluminium, SW. 51 cm, with drum brakes		1.027,00 €

Accessories for Barracuda and Dolphin wheelchairs

Item nr.	Description	Foto	Price
271082	Anti-tip protector with one wheel, right/left for Dolphin/Barracuda	H1H	46,00 €
271085	Transit wheels for Dolphin/Barracuda, pairs	H1I	81,00 €
271086	Steppedal for Dolphin/Barracuda	H1J	15,00 €
271A81	Height and angle adjustable leg rest for Dolphin/Barracuda, SW 40 cm, left	H1F	256,00 €
271A82	Height and angle adjustable leg rest for Dolphin/Barracuda, SW 40 cm, right	H1F	256,00 €
271A83	Height and angle adjustable leg rest for Dolphin/Barracuda, SW 44 cm, left	H1F	256,00 €
271A84	Height and angle adjustable leg rest for Dolphin/Barracuda, SW 44 cm, right	H1F	256,00 €
271A85	Height and angle adjustable leg rest for Dolphin/Barracuda SW, 48 cm, left	H1F	256,00 €
271A86	Height and angle adjustable leg rest for Dolphin/Barracuda, SW 48 cm, right	H1F	256,00 €
271A87	Height and angle adjustable leg rest for Dolphin/Barracuda, SW 51-57 cm, left	H1F	256,00 €
271A88	Height and angle adjustable leg rest for Dolphin/Barracuda, SW 51-57 cm, right	H1F	256,00 €

271075	Head support inkl. fixationsystem for Dolphin/Barracuda	DZ35	202,00 €
--------	---	------	----------

27840H	Seat cushion for Dolphin, 40 x 42-48 x 5 cm (W x D x H)	P3B	44,50 €
27842H	Seat cushion for Dolphin, 42 x 42-48 x 5 cm (W x D x H)	P3B	44,50 €
27844H	Seat cushion for Dolphin, 44 x 42-48 x 5 cm (W x D x H)	P3B	42,50 €
27848H	Seat cushion for Dolphin, 48 x 42-48 x 5 cm (W x D x H)	P3B	49,00 €
27851H	Seat cushion for Dolphin, 51 x 42-48 x 5 cm (W x D x H)	P3B	53,00 €
27854H	Seat cushion for Dolphin, 54 x 42-48 x 5 cm (W x D x H)	P3B	55,00 €
27857H	Seat cushion for Dolphin, 57 x 42-48 x 5 cm (W x D x H)	P3B	58,00 €

271645	Flipback for wheel chair, width 40 cm	PTE9B	47,00 €
271646	Flipback for wheelchair, width 44 cm	PTE9B	47,00 €
271647	Flipback for wheelchair, width 48 cm	PTE9B	51,00 €
271648	Flipback for wheelchair, width 51 cm	PTE9B	50,00 €

271649	Velcroback for wheelchair, SW: 40 - 44 cm	PTE9A	51,00 €
271650	Velcroback for wheelchair, SW: 48 - 51 cm	PTE9A	53,00 €

Spare parts for Barracuda and Dolphin wheelchairs

Item nr.	Description	Price
271627	Arm rest complete with arm rest pad, left	84,00 €
271628	Arm rest complete with arm rest pad, right	84,00 €
271601	Hand grip for pushhandle, black rubber	2,25 €
271603	Handle for fixation of push handle	15,00 €
271A61	Legsupport, complete for Dolphin for SW 40 cm, left	99,00 €
271A62	Legsupport, complete for Dolphin for SW 40 cm, right	99,00 €
271A63	Legsupport, complete for Dolphin for SW 44 cm, left	99,00 €
271A64	Legsupport, complete for Dolphin for SW 44 cm, right	99,00 €
271A65	Legsupport, complete for Dolphin for SW 48 cm, left	99,00 €
271A66	Legsupport, complete for Dolphin for SW 48 cm, right	99,00 €
271A67	Legsupport, complete for Dolphin for SW 51 cm, left	99,00 €
271A68	Legsupport, complete for Dolphin for SW 51 cm, right	99,00 €
271605	PU Arm rest pad 325 mm long, for Dolphin/Barracuda	46,00 €
271602	Push handle incl. hand grip and handle	21,50 €
271604	Push handle incl. hand grip and handle for chairs with drumbrake wheels	26,50 €

Standard spare parts

Item nr.	Description	Price
21520F	20" wheel, black hub ø12 x 53 mm, PU tyre 1 3/8", silver aluminium pushrim	72,00 €
21522F	22" wheel, black, ø12 x 53 mm hub, PU tyre 1 3/8", silver aluminium pushrim	77,00 €
21524F	24" wheel, black, ø12 x 53 mm hub, PU tyre 1 3/8", silver aluminium pushrim	77,00 €
202083	8" Polyurethane wheel, 200 x 45 mm, with distance bushes for 60 mm fork	29,00 €
209060	Fitting clamp for brake ø25 mm tube	7,50 €
209066	Standard tyre brake - left	20,00 €
209065	Standard tyre brake - right	20,00 €

SEAT CUSHIONS

SEAT CUSHIONS



Leaflet P

Seat cushions and swivel cushions

Standard seat cushions

Standard wheelchair cushion made either from high quality cold foam with a high load capacity or with visco-elastic foam. The bottom of the cushion is covered with an anti-slip material. In this way the cushion can be used in any wheelchair without the need to fit with existing Velcro strips. The cover is made from polyester, which is durable, washable and elastic, and is fitted with a zip.

The cushions are 5 cm high and are available in different depths and widths.

Seat cushion with PU foam or high density visco-elastic foam and black polyester or incontinence cover



The cushion seen from the front



Cushion with incontinence cover

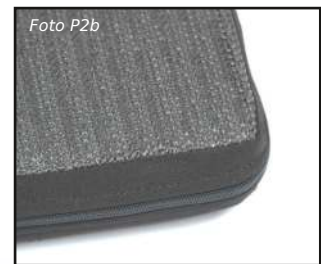

Anti-slip material

The cushions are available in the respective sizes of both polyurethane foam as high density visco-elastic foam. The standard cushion (5 cm in height) is available with a black polyester or incontinence cover. All models are equipped with zip and anti-slip bottom.

Universal wheelchair cushion (adaptable to the seat depth)



The cushion with the closed cover



The cushion with the opened cover and the pre-cutted foam to adapt the seat depth

Universal wheelchair cushion made from high quality foam. The foam comes with pre-cuts so that the cushion is easily adjustable to the depth of the wheelchair seat. The incontinence cover is equipped with Velcro stripes for easy closing.

The cushion is available in seat widths from 40 to 57 cm.
The depth is adjustable from 48 cm to 42 cm.

Seat cushion with a double layer (PU foam and visco-elastic foam)



Incontinence cover



Anti-slip material



Visco-elastic + PU foam

Seat cushion made from one layer of normal PU foam and one layer of visco-elastic foam. It comes with an incontinence cover. The cushion is available in different sizes from 40 to 50 cm.

Wedge cushions



Wedge with incontinence cover

Mobilex wedge with Decutex cover

The wedge cushion is made with 2 layers of foam. The bottom layer is a stable pellet-foam, the upper a visco-elastic foam, which easily adapt.

The Decutex incontinence cover is easy to clean.

Size (W × D × H): 45 × 43 × 10/0 cm

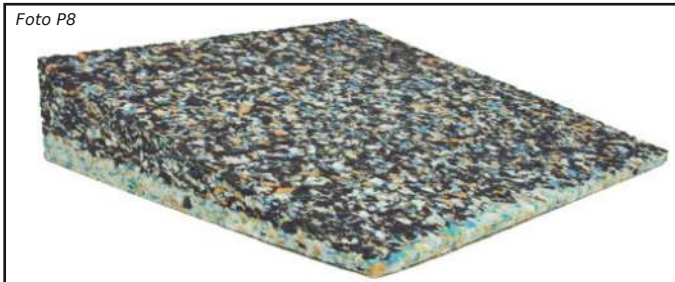

Wedge made of regenerated foam

Mobilex standard wedge

Made of regenerated foam.

Available in 3 sizes (W × D × H):

- 45 × 45 × 6/1 cm
- 45 × 45 × 8/1 cm
- 45 × 45 × 10/1 cm

Swivel cushions (For prices see the leaflet PTR - Transfer products)



Swivel cushion with non-slip base. Ø 45 or 50 cm

The **standard swivel seat cushion** consists of two textile parts joined together. The smooth inner sides make it easier to turn. The upper part consists of a dark blue soft surface, the lower part has a non-slip underside. The cushion is intended to be used as a seat pad in a car, armchair or chair to facilitate turning and transferring of the user.

Diameter: 45 or 50 cm.

Max. Load capacity: 100 kg.



Swivel cushion with non-slip base. Ø 37 or 44 cm

The **Magic Turn swivel seat cushion** consists of two textile parts joined together. The "Magic Turn" model offers greater comfort due to the thicker padding. The insides are slide-coated for excellent turning properties. The bottom part has a non-slip underside. The cushion is designed to be used as a seat base in a car, armchair or chair to facilitate turning and transferring of the user.

Diameter: 37 or 44 cm. Max. Load capacity: 130 kg.



Swivel standing with non slip bottom, Ø 37 cm.

The **Magic-Turn swivel standing** consists of two textile parts connected to each other. The insides are slide-coated to make it easier to turn. The upper part has a soft surface, the lower part is equipped with a non-slip underside. The turntable is intended as a transfer aid, e.g. from bed to chair, etc., and supports turning on its own axis. Can also be used in wet areas as both the top and bottom have an anti-slip coating.

Diameter: 37cm. Max. Load capacity: 130 kg.

Wheelchair cushion from PU foam with friction bottom

Item nr.	Description	Foto	Price
278371	Wheelchair cushion with black cover 37,5 x 40 x 5 cm (W x D x H)	P1	31,00 €
27840L	Wheelchair cushion with black cover, 40 x 40 x 5 cm (W x D x H)	P1	31,00 €
278401	Wheelchair cushion with black cover, 40 x 43 x 5 cm (W x D x H)	P1	33,00 €
27840M	Wheelchair cushion with black cover, 40 x 45 x 5 cm (W x D x H)	P1	33,00 €
27842L	Wheelchair cushion with black cover, 42,5 x 40 x 5 cm (W x D x H)	P1	31,00 €
278421	Wheelchair cushion with black cover, 42,5 x 43 x 5 cm (W x D x H)	P1	34,00 €
27842M	Wheelchair cushion with black cover, 42,5 x 45 x 5 cm (W x D x H)	P1	34,00 €
27845L	Wheelchair cushion with black cover, 45 x 40 x 5 cm (W x D x H)	P1	33,00 €
278451	Wheelchair cushion with black cover, 45 x 43 x 5 cm (W x D x H)	P1	35,00 €
27845M	Wheelchair cushion with black cover, 45 x 45 x 5 cm (W x D x H)	P1	35,00 €
27847L	Wheelchair cushion with black cover, 47,5 x 42 x 5 cm (W x D x H)	P1	35,00 €
27847M	Wheelchair cushion with black cover, 47,5 x 48 x 5 cm (W x D x H)	P1	35,00 €
27850L	Wheelchair cushion with black cover, 50 x 42 x 5 cm (W x D x H)	P1	35,00 €
27850S	Wheelchair cushion with black cover, 50 x 45 x 5 cm (W x D x H)	P1	37,50 €
27850M	Wheelchair cushion with black cover, 50 x 48 x 5 cm (W x D x H)	P1	37,50 €

Wheelchair cushion from PU foam with friction bottom

Item nr.	Description	Foto	Price
278372	Wheelchair cushion with black incontinence cover, 37,5 x 40 x 5 cm (W x D x H)	P2A	36,00 €
278373	Wheelchair cushion with black incontinence cover, 37,5 x 43 x 5 cm (W x D x H)	P2A	38,50 €
27840N	Wheelchair cushion with black incontinence cover, 40 x 40 x 5 cm (W x D x H)	P2A	38,50 €
278402	Wheelchair cushion with black incontinence cover, 40 x 43 x 5 cm (W x D x H)	P2A	38,50 €
27840P	Wheelchair cushion with black incontinence cover, 40 x 45 x 5 cm (W x D x H)	P2A	40,50 €
27842N	Wheelchair cushion with black incontinence cover, 42,5 x 40 x 5 cm (W x D x H)	P2A	40,50 €
278422	Wheelchair cushion with black incontinence cover, 42,5 x 43 x 5 cm (W x D x H)	P2A	40,50 €
27842P	Wheelchair cushion with black incontinence cover, 42,5 x 45 x 5 cm (W x D x H)	P2A	41,50 €
27845N	Wheelchair cushion with black incontinence cover, 45 x 40 x 5 cm (W x D x H)	P2A	41,50 €
278452	Wheelchair cushion with black incontinence cover, 45 x 43 x 5 cm (W x D x H)	P2A	41,50 €
27845P	Wheelchair cushion with black incontinence cover, 45 x 45 x 5 cm (W x D x H)	P2A	43,50 €
27847N	Wheelchair cushion with black incontinence cover, 47,5 x 42 x 5 cm (W x D x H)	P2A	46,00 €
27847P	Wheelchair cushion with black incontinence cover, 47,5 x 48 x 5 cm (W x D x H)	P2A	47,00 €
27850N	Wheelchair cushion with incontinence cover, 50 x 42 x 5 cm (W x D x H)	P2A	48,00 €
27850P	Wheelchair cushion with black incontinence cover, 50 x 48 x 5 cm (W x D x H)	P2A	49,00 €

Adjustable wheelchair cushion from PU foam with friction bottom

Item nr.	Description	Foto	Price
27840H	Seat cushion for Dolphin, 40 x 42-48 x 5 cm (W x D x H)	P3B	44,50 €
27842H	Seat cushion for Dolphin, 42 x 42-48 x 5 cm (W x D x H)	P3B	44,50 €
27844H	Seat cushion for Dolphin, 44 x 42-48 x 5 cm (W x D x H)	P3B	42,50 €
27848H	Seat cushion for Dolphin, 48 x 42-48 x 5 cm (W x D x H)	P3B	49,00 €
27851H	Seat cushion for Dolphin, 51 x 42-48 x 5 cm (W x D x H)	P3B	53,00 €
27854H	Seat cushion for Dolphin, 54 x 42-48 x 5 cm (W x D x H)	P3B	55,00 €
27857H	Seat cushion for Dolphin, 57 x 42-48 x 5 cm (W x D x H)	P3B	58,00 €

Two-layer standard wheelchair cushion (viscoelastic+PU)

Item nr.	Description	Foto	Price
27840Q	Wheelchair cushion of viscoelastic foam, with black incontinence cover, 40 x 40 x 8 cm (W x D x H)	P4A	62,00 €
278407	Seatcushion of viscoelastic foam, with black incontinence cover, W: 40 x D: 43 x H: 8 cm, 50 kg foam	P4A	64,00 €
27840R	Seatcushion of viscoelastic foam, with black incontinence cover, 40 x 45 x 8 cm (W x D x H)	P4A	66,00 €
27842Q	Seatcushion of viscoelastic foam, with black incontinence cover, 42,5 x 40 x 8 cm (W x D x H)	P4A	68,00 €
278427	Seatcushion of viscoelastic foam, 42,5 x 43 x 8 cm (W x D x H), 50 kg foam	P4A	68,00 €
27842R	Seatcushion of viscoelastic foam, with black incontinence cover, 42,5 x 45 x 8 cm (W x D x H)	P4A	70,00 €
27842S	Seatcushion of viscoelastic foam, with black incontinence cover, 42,5 x 48 x 8 cm (W x D x H)	P4A	75,00 €
27845Q	Seatcushion of viscoelastic foam, with black incontinence cover, 45 x 40 x 8 cm (W x D x H)	P4A	72,00 €
278457	Seatcushion of viscoelastic foam, 45 x 43 x 8 cm (W x D x H), 60 kg foam	P4A	71,00 €
27845R	Seatcushion of viscoelastic foam, with black incontinence cover, 45 x 45 x 8 cm (W x D x H)	P4A	75,00 €
27845S	Seatcushion of viscoelastic foam, with black incontinence cover, 45 x 48 x 8 cm (W x D x H)	P4A	77,00 €
27845F	Wheelchair cushion of viscolastic foam with incontinence cover, 45 x 50 x 8 cm (W x D x H)	P4A	72,00 €
27847Q	Seatcushion of viscoelastic foam, with black incontinence cover, 47,5 x 42 x 9 cm (W x D x H)	P4A	81,00 €
27847R	Seatcushion of viscoelastic foam, with black incontinence cover, 47,5 x 48 x 9 cm (W x D x H)	P4A	83,00 €
27850Q	Seatcushion of viscoelastic foam, with black incontinence cover, 50 x 42 x 9 cm (W x D x H)	P4A	83,00 €
27850R	Seatcushion of viscoelastic foam, with black incontinence cover, 50 x 48 x 9 cm (W x D x H)	P4A	94,00 €
27855R	Wheelchair cushion of viscoelastic foam, with incontinence cover, 55 x 48 x 9 cm (W x D x H)	P4A	96,00 €

Wheelchair cushion from high density viscoelastic foam with friction bottom

Item nr.	Description	Foto	Price
27840A	Seatcushion of viscoelastisk foam, high density, with polyester cover, W: 40,5 x D: 43 x H: 5 cm	P1	47,00 €
27842A	Seatcushion of viscoelastisk foam, high density, with polyester cover, 42,5 x 43 x 5 cm (W x D x H)	P1	48,00 €
27845A	Seatcushion of viscoelastisk foam, high density, with polyester cover, 45 x 43 x 5 cm (W x D x H)	P1	50,00 €

Wheelchair cushion from high density viscoelastic foam with friction bottom

Item nr.	Description	Foto	Price
27840C	Seat cushion of viscoelastic foam, high density, 40 x 43 x 5 cm	P2A	51,00 €
27842C	Seatcushion of viscoelastisk foam, high density, with incontinence cover, 42,5 x 43 x 5 cm (W x D x H)	P2A	52,00 €
27845C	Seatcushion of viscoelastisk foam, high density, with incontinence cover, 45 x 43 x 5 cm (W x D x H)	P2A	54,00 €

Cushions with wedge form

Item nr.	Description	Foto	Price
278061	Double-layer wedge cushion, 43 x 45 x 10/0 cm, with grey Decutex cover	P7	117,00 €
278064	Granulated foam wedge cushion, 45 x 45 x 6/1 cm	P8	15,00 €
278065	Granulated foam wedge cushion, 45 x 45 x 8/1 cm	P8	17,00 €
278066	Granulated foam wedge cushion, 45 x 45 x 10/1 cm	P8	21,50 €
278069	Anti-incontinence cover with non-slip underside for 6 or 8 cm high wedge pillows	P16	26,50 €
278070	Incontinence cover for wedges with the height 10 cm with anti-slip material in bottom	P17	26,50 €

TEXTILE PRODUCTS



Leflet PTe
Textile products

Kangaroo body warmer for wheelchair users



Mobilex Kangaroo body warmer

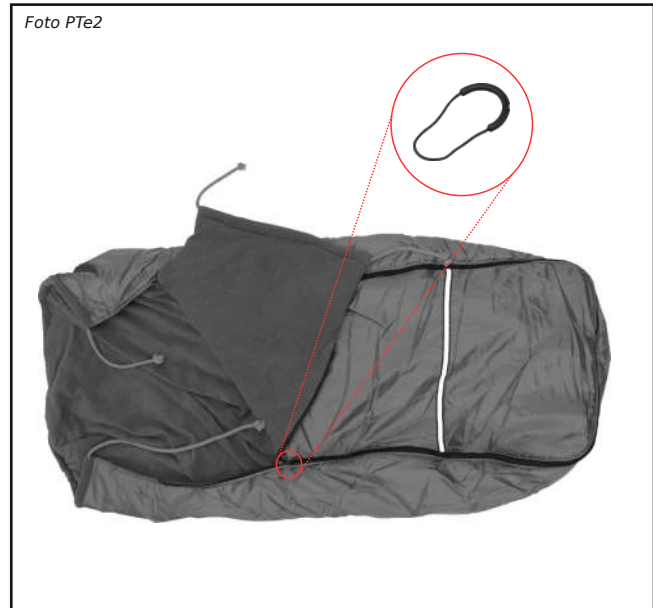

Mobilex Kangaroo body warmer and detail of the zip pull loop (zip handle)

The **Mobilex Kangaroo body warmers** have an anatomical shape and are made of tear-resistant waterproof nylon with a pleasantly warm thermal lining inside. This makes them not only comfortable but also ideal for use on cold and rainy days.

The body warmers are equipped with a large all-round zip that is easy to operate and have a non-slip underside. There is a convenient pocket at the front which is also equipped with a zip with a large handle eyelet. Two reflective stripes on the front increase safety on public roads. An adjustable back strap and elastic loops allow for secure attachment to the back or push handles of the wheelchair.

The Mobilex Kangaroo body warmers are available in 3 different sizes. Small, Medium and Large.

Ponchos



Poncho for Rollator users

Poncho for rollator users, made of dark grey polyester with reflective stripes. Hood with side viewing window, as well as 2 side openings with zips for the arms and a fastening strap against wind flutter.



Poncho for wheelchair users

Poncho for wheelchair users, consisting of grey polyester with reflective stripes and hood with side viewing window. At the back, the poncho has a cover for the wheelchair back.

Weatherproof leg warmer



Weatherproof thermal leg warmer

Weatherproof thermal leg warmer for scooter riders to protect the lower body. The outer material is polyurethane-coated and lined on the inside. Equipped with an elastic back strap with quick release fastener. Available in 2 sizes.

Weatherproof scooter cover



Weatherproof cover for scooters

Weatherproof cover for scooters. Made of tear-resistant black PVC.

Available in 3 sizes.

Wheel bags



Mobilex bag for two 24" wheels



Spinergy bag for two wheels up to 28"

The **Mobilex wheel bags** are made of tear-resistant black nylon with red stitching, carrying handles and removable carrying strap. The Mobilex bag has two separate wheel bags for 1 complete 24" wheel each. There is an internal pocket for small wheel accessories (thru axles etc.). The Spinergy wheel bags are also made of tear-resistant black nylon with red zips. The Spinergy bag can hold 2 wheels up to 28".

Wheelchair bag



Universal wheelchair bag



Universal side bag for wheelchairs

Stylish universal **wheelchair bag** made of tear-resistant black nylon. Equipped with 2 straps to attach the bag to the backrest or to the side of the wheelchair. The bag for the backrest also comes with a convenient carrying strap.

Velcro back for wheelchairs



Velcro back

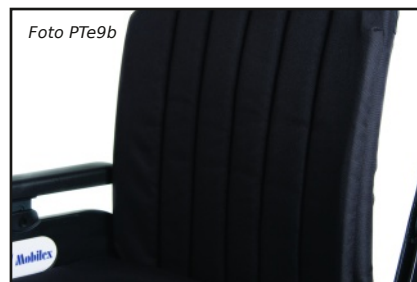

Flip back cover

The **Mobilex adjustable back** consists of 2 parts. The Velcro back with the belt buckles and the Flip back. It can be adjusted to individual needs.

SoftSleep orthopaedic pillow

The **SoftSleep** pillow is made of high-density, open-cell PU foam also called "Slow Foam" or "Memory Foam". This material has unique properties: it reacts to body weight and temperature fluctuations. Warmed by the user's body heat, it adapts its shape to the profile of the neck and head.

Thanks to the shaping, the forces acting on the neck and head during sleep are alleviated and it helps eliminate headaches, neck and back pain. It can also help prevent or combat insomnia. The SoftSleep pillow thus increases the quality of sleep exceptionally.

The cover of the pillow was specially developed for this type of product. It not only helps to distribute body heat, but also has a hygienic function: the fabric has anti-fungal and anti-bacterial properties.

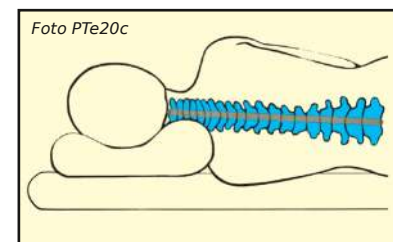

Rain ponchos

Item nr.	Description	Foto	Price
279012	Waterproof rain poncho for rollator users, Small	PTE3	61,00 €
279013	Waterproof rain poncho for rollator users, Large	PTE3	63,00 €
279014	Waterproof rain poncho for wheelchair users	P15B	58,00 €

Kangaroo body warmer for wheelchair users

Item nr.	Description	Foto	Price
279021	Kangaroo Wheelchair Body Warmer, grey, Small	PTE2	104,00 €
279022	Kangaroo Wheelchair Body Warmer, grey, Medium	PTE2	104,00 €
279023	Kangaroo Wheelchair Body Warmer, grey, Large	PTE2	115,00 €

279025	Zip Grip, XL zipper grip with 40 mm handle	PTE2A	5,25 €
--------	--	-------	--------

Thermocovers for scooter driver

Item nr.	Description	Foto	Price
279003	Thermocover for scooter driver, medium model	PTE5	84,00 €
279002	Thermocover for scooter driver, large model	PTE5	92,00 €

Scooter cover from waterproof material

Item nr.	Description	Foto	Price
279001	Scooter cover from waterproof material, M, 62 x 100 x 125 cm (W x H x L)	PTE6	77,00 €
279004	Scooter cover from waterproof material, L, 72 x 120 x 150 cm (W x H x L)	PTE6	84,00 €
279005	Scooter cover from waterproof material, XL, 72 x 120 x 175 cm (W x H x L)	PTE6	105,00 €

Wheel bags

Item nr.	Description	Foto	Price
279036	Mobilex wheel bag for 2 wheels from 20" to 24"	PTE7	64,00 €
279035	Spinergy wheel bag for 2 wheels - 20" - 28"	PTE8	213,00 €

Wheelchair bag (for attaching to the wheelchair)

Item nr.	Description	Foto	Price
279052	Bag 35 x 31 x 12 cm, to attach to the back of the wheelchair	PTE10	35,00 €
279053	Bag 31 x 21 x 14 cm, for side mounting on the wheelchair	PTE11	32,50 €

Wheelchair back (2-piece - consisting of Velcro back and Flip back)

Item nr.	Description	Foto	Price
271649	Velcroback for wheelchair, SW: 40 - 44 cm	PTE9A	51,00 €
271650	Velcroback for wheelchair, SW: 48 - 51 cm	PTE9A	53,00 €

271645	Flipback for wheel chair, width 40 cm	PTE9B	47,00 €
271646	Flipback for wheelchair, width 44 cm	PTE9B	47,00 €
271647	Flipback for wheelchair, width 48 cm	PTE9B	51,00 €
271648	Flipback for wheelchair, width 51 cm	PTE9B	50,00 €

Orthopedic pillow SoftSleep

Item nr.	Description	Foto	Price
279061	SoftSleep Contour pillow with Memory Foam, 50 x 30 x 9-11.5 cm	52	28,60 €

Dimension tables of Kangaroo body warmers and thermocovers

Kangaroo body warmer for wheelchair users

The Mobilex Kangaroo body warmers are made of tear-resistant and waterproof nylon with a polyester lined thermal inside. The body warmer is equipped with a zipper on both sides. Color gray. Available in 3 sizes (Small, Medium, Large).

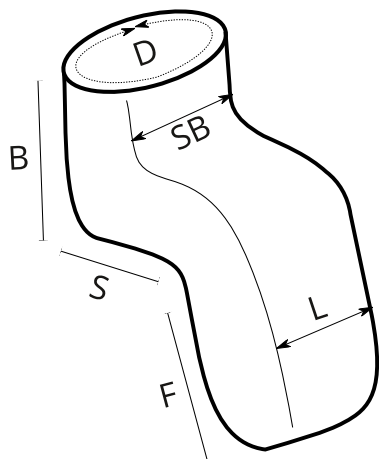

Dim.	Small	Medium	Large
B	42 cm	44 cm	46 cm
SB	40-45 cm	45-48 cm	48-51 cm
S	40 cm	45 cm	50 cm
F	40 cm	45 cm	50 cm
L	42 cm	46 cm	50 cm
D	90 cm	110 cm	125 cm

Item nr.	Description	for SW	Dim.
279021	Kangaroo body warmer	40-45 cm	Small
279022		45-48 cm	Medium
279023		48-51 cm	Large

Thermocover for scooter drivers

Weatherproof thermocover for scooter drivers to protect the lower body. The outer material is polyurethane coated and lined inside. For fastening, an elastic back strap with quick-release fastener is attached at the back. Colour black. Available in 2 sizes (Medium and Large).

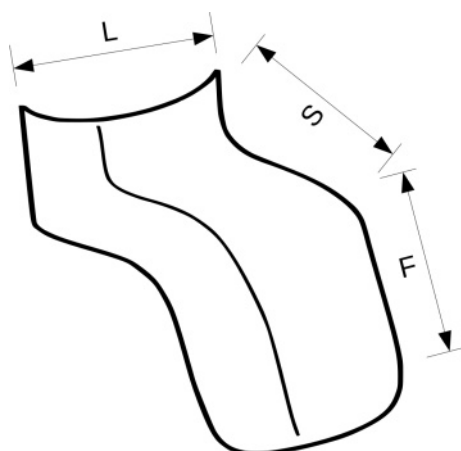

Dim.	Medium	Large
S	40 cm	55 cm
F	60 cm	60 cm
L	40 cm	55 cm

Item nr.	Description	for SW	Dim.
279003	Weatherproof thermocover for scooter drivers	42 - 45 cm	Medium
279002		45 - 52 cm	Large

TRANSFER PRODUCTS



Leaflet PTr

Transfer and positioning products

Mobiglide transfer boards

The **Mobiglide transfer boards** are made of 6 mm thick white translucent polypropylene, or 6 mm thick white PVC. The low frictional resistance of the Mobilex transfer boards makes transferring to or from the wheelchair much easier.

Anti-slip strips are available as accessories, which can be attached to the underside of the board to prevent it from sliding away.

The polypropylene boards are available in three sizes: 650 × 245 mm, 800 × 245 mm and in curved form 800 × 348 mm. The PVC board is only available in the size 800 × 245 mm.

The transfer boards are loadable up to 150 kg (with max. 20 cm intermediate distance).



Transfer board from polypropylene or PVC

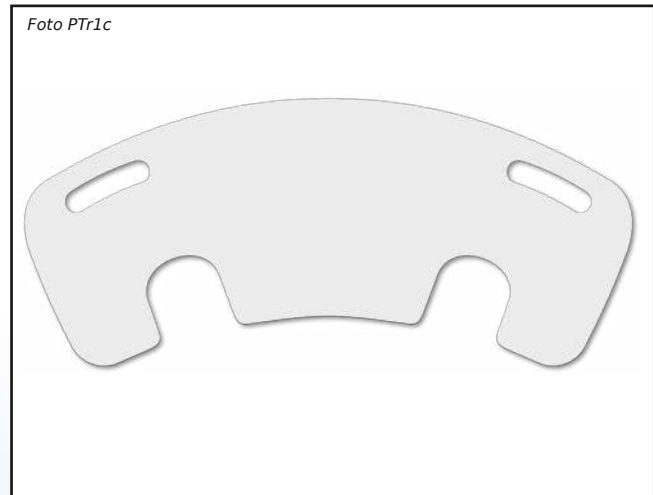

Curved transfer board from polypropylene

Mobiglide patient transfer board

The **Mobiglide patient transfer board** made of break-proof 6 mm thick HDPE has a high sliding ability on the upper side and helps when transferring patients from bed to bed. In hospitals or nursing homes it can also be used in oncology for X-rays as the material allows X-rays to pass through.

Anti-slip strips are available as an accessory that can be attached to the underside of the board to prevent it from sliding away.

The Mobiglide patient transfer board has a size of 1500 × 700 mm. The load capacity is 200 kg with a max. distance of 20 cm and a max. height difference of 10 cm.

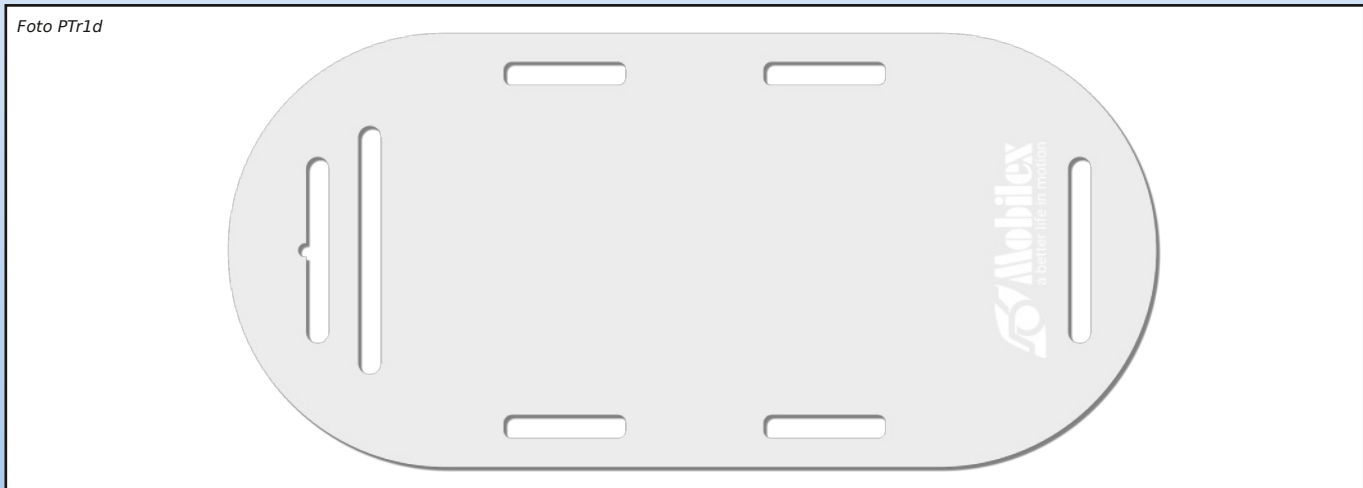

Mobiglide patient transfer board

Mobiglide positioning products

Tube slide sheets



Tube slide sheet

The **Mobiglide tube slide sheets** offer extremely low frictional resistance on the inside and outside, thus minimizing friction when transferring patients.

The tube slide sheets are available in 3 sizes.
Load capacity: 250 kg
Material: nylon

Flat sliding sheets



Flat sliding sheet (to be used in pairs)

The **Mobiglide flat sliding sheets** reduce the frictional forces when transferring or moving people in bed.

The sliding sheet is to be used in pairs.

Size: 150 × 100 cm or 200 × 100 cm
Load capacity: 250 kg

Slide sheet with handles



Slide sheet with handles

The **Mobiglide slide sheet with handles** makes positioning of sitting or lying patients easier than well as transferring a lying patient from a bed to a stretcher. The use of two tube slide sheets makes it easier to place the lifting sling under the patient.

Available in 100 × 200 cm, Max. Load 250 kg
Material: Nylon

One-way Slide



One way slide mat

The **Mobiglide one-way slide** mat prevents the user from gliding forward in the wheelchair. The internal velour can only slide in one direction and prevents the user from slipping unintentionally forward. The sliding mat also facilitates the user to transfer back to his original seating position.

Size: 45 × 50 cm
Max. Load 250 kg

Mobiglide sliding gloves

Foto PTR2e



Sliding gloves

The **Mobiglide sliding gloves** make it easier to slide under the patient, e.g. to check the filling level of an anti-decubitus product. They also make it easier to carry out positioning or repositioning.

Scope of delivery: 1 pair
Size: 50 × 20 cm

Support belt

Foto PTR3



Support belt with handles

The **Mobilex support belt** helps caregivers to lift patients out of bed, chair or wheelchair and to travel short distances with them. This can be a supportive aid when getting up from sitting or vice versa, e.g. from the wheelchair or bed, the car, the toilet, etc. Furthermore, the support belt can be used to support the patient during gait training.

Sizes: 117 × 14 cm (M) or 140 × 14 cm (L)
Load capacity: 180 kg

Swivel cushions

Foto PTR4a



Swivel cushion with non-slip base. Ø 45 or 50 cm

The **standard swivel seat cushion** consists of two textile parts joined together. The smooth inner sides make it easier to turn. The upper part consists of a dark blue soft surface, the lower part has a non-slip underside. The cushion is intended to be used as a seat pad in a car, armchair or chair to facilitate turning and transferring of the user.

Diameter: 45 or 50 cm.
Max. Load capacity: 100 kg.

Foto PTR4b



Magic-Turn swivel cushion with non-slip base. Ø 37 or 44 cm

The **Magic Turn swivel seat cushion** consists of two textile parts joined together. The "Magic Turn" model offers greater comfort due to the thicker padding. The insides are slide-coated for excellent turning properties. The bottom part has a non-slip underside. The cushion is designed to be used as a seat base in a car, armchair or chair to facilitate turning and transferring of the user.

Diameter: 37 or 44 cm.
Max. Load capacity: 130 kg.

Foto PTR4c



Magic-Turn Swivel standing cushion with non-slip bottom, Ø 37 cm.

The **Magic-Turn swivel standing cushion** consists of two textile parts connected to each other. The insides are slide-coated to make it easier to turn. The upper part has a soft surface, the lower part is equipped with a non-slip underside. The turntable is intended as a transfer aid, e.g. from bed to chair, etc., and supports turning on its own axis. Can also be used in wet areas as both the top and bottom have an anti-slip coating.

Diameter: 37 cm.
Max. Load capacity: 130 kg.

Mobiglide transfer boards

Item nr.	Description	Foto	Price
240501	Transfer board from Polypropylene, 650 x 245 x 6 mm (L x W x H)	PTR1A	55,00 €
240502	Transfer board from polypropylene, 800 x 245 x 6 mm (L x W x H)	PTR1A	66,00 €
240505	Transfer board from PVC in grey - 800 x 245 x 6 mm (L x W x H)	PTR1A	73,00 €
240507	Curved transfer board from polypropylene, 800 x 345 x 6 mm (L x W x H)	PTR1C	83,00 €
240701	Patient transfer board from Polypropylen, 1500 x 700 x 6 mm (L x W x H)	PTR1D	317,00 €

Mobiglide tube slide sheet

Item nr.	Description	Foto	Price
278011	Tube slide sheet 70 x 68 cm	PTR2A	36,00 €
278012	Tube slide sheet 140 x 68 cm	PTR2A	63,00 €
278013	Tube slide sheet 200 x 68 cm	PTR2A	81,00 €

Mobiglide flat slide sheet with handles

Item nr.	Description	Foto	Price
278023	Flat slide sheet with handles 100 x 200 cm	PTR2B	116,00 €

Mobiglide flat slide sheet (to be used in pairs)

Item nr.	Description	Foto	Price
278015	Flat slide sheet 150 x 100 cm (to be used in pairs)	PTR2C	65,00 €
278016	Flat slide sheet 200 x 100 cm (to be used in pairs)	PTR2C	79,00 €

Mobiglide one-way slide sheet

Item nr.	Description	Foto	Price
278031	One-way slide mat 45 x 50 cm	PTR2D	75,00 €

Mobiglide transfer gloves

Item nr.	Description	Foto	Price
278041	Transfer gloves, 50 x 20 cm, blue, pairs	PTR2E	29,00 €

Support belt

Item nr.	Description	Foto	Price
278046	Support belt with handles, Medium, 117 x 14 cm	PTR3	89,00 €
278047	Support belt with handles, Large, 140 x 14 cm	PTR3	97,00 €

Swivel seat

Item nr.	Description	Foto	Price
278051	Swivel seat cushion ø45 cm	PTR4A	38,50 €
278052	Swivel seat cushion ø50 cm	PTR4A	42,50 €
278055	Swivel seat cushion ø37 cm, Magic Turn	PTR4B	53,00 €
278056	Swivel seat cushion ø44 cm, Magic Turn	PTR4B	67,00 €

Standing swivel plate

Item nr.	Description	Foto	Price
278058	Standing swivel plate ø37 cm	PTR4C	75,00 €

LEVABO[®] CUSHIONS

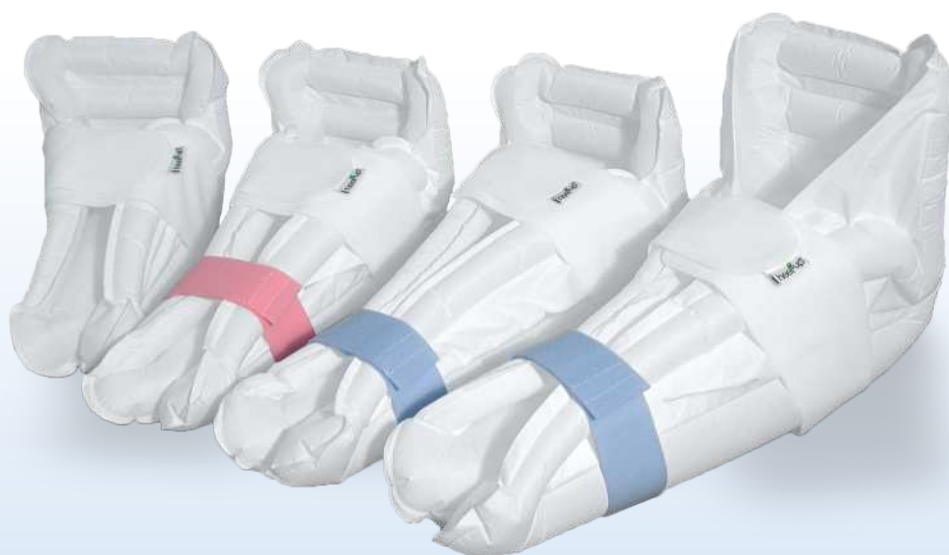

Leaflet PX
Levabo[®] cushions

heel-up®

heel-up® and all-up® are Levabo®'s new products in the treatment and prevention of pressure ulcers. The range has been developed in collaboration with leading wound care nurses and ensures optimum comfort and hygiene in the treatment and prevention of pressure ulcers.



heel-up® and all-up® are suitable for efficient prevention and treatment of pressure ulcers on the most exposed areas such as heels, hips, elbows, shoulders, back etc.

The products are multi-functional, i.e., the same product can be used in different configurations to optimise the prevention and treatment of pressure ulcers.

heel-up® and all-up® are user-specific disposable products with an ergonomic design that provides good stability. The external layer is made of soft, flexible, heat and moisture absorbent nonwoven material, which makes the heel-up® and all-up® comfortable to lie with and sit on.

Simple to use: heel-up® and all-up® inflated before use and adjusted to the user's anatomy and needs.

Foto PX1a



heel-up® short

Foto PX1b



heel-up® medium

Foto PX1c



heel-up® long

Foto PX1d



heel-up® max

- Single patient use ensures high hygiene.
- heel-up® is designed to prevent and treat pressure ulcers in the heel region.
- all-up® is designed to prevent and treat pressure ulcers on elbows, shoulders back etc.
- Easy & simple to use.
- Good comfort.
- Soft, skin-friendly and moisture absorbent material.
- Space saving in the depot.
- Available in clean, sealed and slim packaging inclusive an inflation device.
- Tested and approved in accordance with ISO 10993-10 Skin irritation and sensitization.
- Available in different sizes.

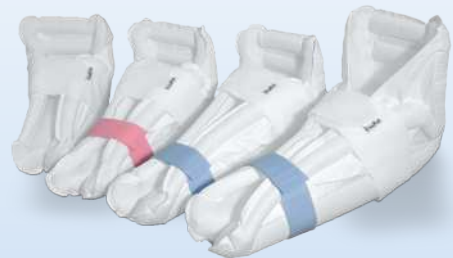

Levabo® air pumps

Foto PX20a



Foto PX20b



Foto PX20c



all-up®

all-up® is Levabo®'s new hygienic and environmentally friendly single-patient inflatable positioning products. The range has been developed in collaboration with leading wound care nurses and ensures optimum comfort and hygiene in the treatment and prevention of pressure ulcers. all-up® is suitable for effective treatment and prevention of bruises on the most vulnerable locations for example heels, hips, elbows, shoulders, back etc. The products are multi-functional, i.e. the same product can be used in different configurations to optimise the prevention and treatment of pressure ulcers. all-up® is user-specific disposable product in ergonomic design, providing good stability. The outer layer is made of soft, flexible, heat and moisture absorbent nonwoven material, which makes all up® comfortable to lie with and sit on. Simple to use: all-up® inflated before use and adjusted to the user's anatomy and needs.

Foto PX2a



all-up® small

Foto PX7a



all-up® universal

Foto PX3a



all-up® head

Foto PX8a



all-up® seat

Foto PX4a



all-up® donut

Foto PX9a



all-up® back & seat

Foto PX5a



all-up® kidney

Foto PX10a



all-up® bath

Foto PX6a





all-up® tailbone

Foto PX11a





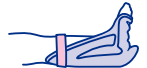
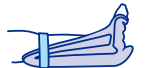

all-up® wing

Heel Up

Item nr.	Description	Foto	Price
277001	Levabo Heel Up, 18 x 32 x 25 cm, (B x L x H), small, with 3 inlays		PX1A 30,00 €
277006	Levabo Heel Up, 18 x 32 x 25 cm, (B x L x H), small		PX1A 27,50 €
277002	Levabo Heel Up, 18 x 39 x 25 cm, (B x L x H), medium, with 3 inlays		PX1B 30,00 €
277007	Levabo Heel Up, 18 x 39 x 25 cm, (B x L x H), medium		PX1B 27,50 €
277003	Levabo Heel Up, 18 x 48 x 25 cm, (B x L x H), large, with 3 inlays		PX1C 30,00 €
277008	Levabo Heel Up, 18 x 48 x 25 cm, (B x L x H), large		PX1C 27,50 €
277004	Levabo Heel Up, 18 x 50 x 30 cm, (B x L x H), XL, with 3 inlays		PX1D 30,00 €
277009	Levabo Heel Up, 18 x 50 x 30 cm, (B x L x H), XL		PX1D 27,50 €

All Up Multi

Item nr.	Description	Foto	Price
277011	Levabo All Up Multi, 50 x 25 x 8 cm (W x L x H), small		PX2A 19,00 €
277012	Levabo All Up Multi, 50 x 37 x 8 cm (W x L x H), medium		PX2B 19,00 €
277013	Levabo All Up Multi, 50 x 50 x 8 cm (W x L x H), large		PX2C 21,50 €
277014	Levabo All Up Multi Max, 50 x 50 x 20 cm (W x L x H)		PX2C 25,50 €

All Up Head

Item nr.	Description	Foto	Price
277021	Levabo All Up, Head, 28 x 30 x 5 cm (W x L x H)		PX3A 19,00 €

All Up Seat Donut

Item nr.	Description	Foto	Price
277025	Levabo All Up, Donut, 45 x 45 x 8 cm (W x L x H)		PX4A 21,50 €

All Up Kidney

Item nr.	Description	Foto	Price
277026	Levabo All Up, Kidney, 50 x ø20 cm (L x diameter)		PX5A 21,50 €

All UPSeat Tailbone

Item nr.	Description	Foto	Price
277029	Levabo All Up, Tailbone, 42 x 42 x 5 cm (W x L x H)		PX6A 23,50 €

All Up Universal

Item nr.	Description	Foto	Price	
277034	Levabo All Up, Universal slim, 45 x 75 x 8 cm (W x L x H), long		23,50 €	
277031	Levabo All Up, Universal, 50 x 50 x 8 cm (B x L x H), standard		PX7A	21,50 €
277032	Levabo All Up, Universal, 70 x 55 x 8 cm (W x L x H), long		PX7A	23,50 €

All Up Seat

Item nr.	Description	Foto	Price	
277041	Levabo All Up, Seat, 42 x 42 x 5 cm (B x L x H), small		PX8A	23,50 €
277043	Levabo All Up, Seat, 52 x 52 x 5 cm (B x L x H), large		PX8A	25,50 €
277044	Levabo All Up, Seat, 52 x 62 x 5 cm (W x L x H), max		PX8A	25,50 €

All Up Seat Back & Seat

Item nr.	Description	Foto	Price	
277042	Levabo All Up, Back and Seat, 45 x 27 x 5 cm (B x L x H)		PX9A	23,50 €

All Up Seat Bath

Item nr.	Description	Foto	Price	
277045	Levabo All Up, Bath, 50 x 50 x 8 cm (W x L x H)		PX10A	23,50 €

All Up Arm Rest

Item nr.	Description	Foto	Price	
277016	Levabo All Up, Arm Rest, 55 x 25 x 8 cm (W x L x H)		PX3A	19,00 €

All Up Elbow / Elbow & Heel

Item nr.	Description	Foto	Price	
277017	Levabo All Up, Elbow, 30 x 20 x 10 cm (W x L x H)		PX3A	27,50 €
277015	Levabo All Up, Elbow & Heel, 30 x 20 x 10 cm (W x L x H)			31,00 €

All Up Lap

Item nr.	Description	Foto	Price	
277018	Levabo All Up, Lap, 80 x 60 x 10 cm (W x L x H)		PX3A	27,50 €
277019	Levabo All Up Lap Max, 80 x 60 x 20 cm (W x L x H)		PX3A	27,50 €

All Up Wedge

Item nr.	Description	Foto	Price	
277020	Levabo All Up Wedge 30 deg., 70 x 40 x 15 cm (W x L x H)		PX3A	27,50 €

All Up Wing

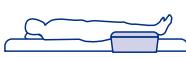
Item nr.	Description	Foto	Price	
277051	Levabo All Up, Wing, 50 x 85 x 8 cm (W x L x H)		PX11A	27,50 €

All Up Belly

Item nr.	Description	Foto	Price	
277027	Levabo All Up Belly, 65 x 75 x 15 cm (W x L x H)		PX5A	23,50 €

All Up Twin

Item nr.	Description	Foto	Price	
277030	Levabo All Up Twin, 48 x 52 x 5 cm (W x L x H)		PX6A	27,50 €

Mobilex A/S - Price list

All prices are per pcs. and in EUR.

07.2022

Leaflet PX

Levabo spare parts and accessories

Item nr.	Description	Foto	Price
277101	Levabo hand pump	PX20A	20,00 €
277102	Levabo battery pump	PX20B	298,00 €
277103	Levabo electric pump	PX20C	92,00 €
277005	Levabo Heel Up inlay, 35 x 50 cm, bag with 10 pcs		23,50 €
277081	Levabo All Up, Cover for Seat, 42 x 42 cm, 5 pcs		30,00 €
277201	Levabo polyester bag	PX20D	55,00 €
277202	Levabo Adapter set		27,50 €

BATTERIES BATTERIES



Leaflet J

Batteries and chargers
for e-wheelchairs, scooters or lifters

Foto J1



EXIDE® Gel Batteries (series GF and GY)



EXIDE® GEL batteries

The new EXIDE GEL is a battery that combines the strengths of the two Dryfit battery types Dryfit Sportline and Dryfit Start at the highest quality level. The EXIDE GEL battery offers reliable starting power plus maximum supply energy for heavy cyclical use in professional applications. With only 14 types, the EXIDE GEL offers an enormous variety of application possibilities.

- Closed and maintenance-free system
- Low self-discharge
- Acid does not leak even when batteries are tipped over
- IATA approved. Not classified as dangerous cargo and therefore also approved for use in aircraft.
- No unpleasant acid smell when charging in closed rooms
- The GV series with thin lead plates allows a higher starting current and better acceleration values (min. for 450 charging cycles)
- The GY series has thicker lead plates and allows more charging cycles (min. 600 cycles)
- Different sizes and thicknesses also available for lifters

Terminal types for GEL batteries

A-Terminal



F-M6



G-M6

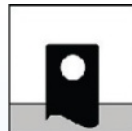

FirstPower® AGM batteries

AGM batteries are sealed and maintenance-free batteries with a long service life.

Batteries from 2 Ah to 7.2 Ah are available from stock, suitable e.g. for the most common models of passenger lifts.

Foto J3



FirstPower® AGM Batteries

Foto J5



Victron 24 V impuls charger 8A

The **Victron Impulse chargers** are optimized for charging the batteries of electric wheelchairs, scooters or other vehicles with closed and maintenance-free lead-acid batteries, serially coupled to 24V.

The chargers are easy to operate and special attention was paid during development to a high level of safety for both the user and the batteries.

Victron 24 V Impulse chargers	GL0601	GL0801
<i>Mains voltage</i>	230 V	230 V
<i>Nominal charging voltage</i>	24 V	24 V
<i>Max. Charging current.</i>	6 A	8 A
<i>Power</i>	180 W	250 W
<i>Recommended battery size</i>	40 – 60 Ah	60 – 85 Ah
<i>Dimensions H × W × L</i>	80 × 65 × 168 mm	80 × 65 × 168 mm
<i>Weight</i>	1 kg	1 kg
<i>Safety class</i>	IP 65	IP 65
<i>Max. Charging voltage</i>	28,8 V	28,8 V
<i>Maintenance charging voltage</i>	27,4 V	27,4 V

EXIDE® Gel batteries for Electric wheel chairs and Scooters

Foto J1

Item nr.	Description	Price
GY1122	Gel battery 12 V 25 A G-M6 167 x 176x 126m (L x W x H)	170,00 €
GY1125	Gel battery 12 V 25 A G-M6 197 x 132 x 180 mm (L x W x H)	184,00 €
GY1033	Gel batteri 12 V 33 A A POL 210 x 175 x 175 mm (L x B x H)	234,00 €
GY1133	Gel battery 12 V 33 A G-M6 210 x 175 x 175 mm (L x B x H)	234,00 €
GY1040	Gel batteri 12 V 40 A A POL 242 x 175 x 190 mm (L x B x H)	351,00 €
GY1044	Gel battery 12 V 44 A 261 x 135 x 230 mm (L x W x H)	320,00 €
GV1050	Gel battery 12 V 50 A 278 x 175 x 190 mm (L x W x H)	309,00 €
GY1051	Gel batteri 12 V 51 A A POL 278 x 175 x 190 mm (L x B x H)	330,00 €
GY1063	Gel batteri 12 V FM6 A POL 260 x 171 x 210 mm (L x B x H)	386,00 €
GY1070	Gel battery 12 V 70 A 330 x 171 x 236 mm (L x W x H)	404,00 €

FirstPower® AGM Batteries for Lifters

Foto J3

Item nr.	Description	Price
GS1212	Agm battery 12v 1.2A - 58 x 46 x 97 mm (H x W x L)	13,00 €
GS1219	Agm battery 12v 1.9A - 60 x 34 x 178 mm (H x W x L)	11,05 €
GS1227	Agm battery 12v 2.7A - 60 x 34 x 178 mm (H x W x L)	17,23 €
GS1229	Agm battery 12v 2.9A - 100 x 56 x 80 mm (H x W x L)	15,93 €
GS1245	Agm battery 12v 4.5A - 99 x 70 x 90 mm (H x W x L)	15,93 €
GS1272	Agm battery 12v 7A - 65 x 94 x 151 mm (H x B x L)	21,45 €
GS1012	Agm battery 12v 12Ah - 95 x 98 x 151mm H x B x L (for Lille Viking)	35,10 €

Chargers

Foto J5

Item nr.	Description	Price
GL0601	Victron impulse charger 24V 6A	250,00 €
GL0801	Victron impulse charger 24V 8A	266,00 €

Matrix for Mobilex GY and GV Batteries

Hersteller	Modell	Itemnr.	Poltyp	Ah 5 Std	L x B x H
<i>Karma</i>	<i>737-747</i>	GY1133	G-M6	33 Ah	195 x 175 x 175 mm
<i>Minicrosser</i>	<i>115 S</i>	GY1051	A	51 Ah	278 x 175 x 190 mm
<i>Minicrosser</i>	<i>120 - 130 T</i>	GY1051	A	51 Ah	278 x 175 x 190 mm
<i>Pride</i>	<i>Calyпсо</i>	GY1040	A	40 Ah	242 x 175 x 190 mm
<i>Pride</i>	<i>Jazzy 1103</i>	GY1133	G-M6	33 Ah	195 x 175 x 175 mm
<i>Pride</i>	<i>Jazzy 1120</i>	GY1051	A	51 Ah	278 x 175 x 190 mm
<i>Invacare</i>	<i>Auriga 10</i>	GY1133	G-M6	33 Ah	195 x 175 x 175 mm
<i>Invacare</i>	<i>Meteor</i>	GY1063	F-M6	63 Ah	260 x 171 x 210 mm
<i>Invacare</i>	<i>Mirage/Mistral</i>	GY1133	G-M6	33 Ah	195 x 175 x 175 mm
<i>Invacare</i>	<i>Moover 85</i>	GY1040	A	40 Ah	242 x 175 x 190 mm
<i>Invacare</i>	<i>Moover Delta II</i>	GY1051	A	51 Ah	278 x 175 x 190 mm
<i>Roltec</i>	<i>Vision</i>	GV1070	A	70 Ah	330 x 171 x 236 mm
<i>Meyra</i>	<i>Cityliner 312</i>	GY1133	G-M6	33 Ah	195 x 175 x 17 mm
<i>Meyra</i>	<i>Euro Sprint</i>	GY1051	A	51 Ah	278 x 175 x 190 mm
<i>Meyra</i>	<i>Optimus</i>	GY1051	A	51 Ah	278 x 175 x 190 mm

WHEELCHAIR RAMPS

WHEELCHAIR RAMPS



Leaflet L

Wheelchair ramps made of aluminium

Channel-ramps type CH

The ramp is made of aluminium with a friction surface and consists of two separate drive-on rails that are hinged at the middle. Folded the ramp can be carried with 2 handles like a suitcase.

The CH ramps must be used in pairs.



CH Ramps in use



CH Ramps folded for transport

CH-Ramps	CH-180
Length	180 cm
Width (per rail)	23,5 cm
Surface width	21 cm
Height of side protect.	Außen / Innen: 6 / 3,3 cm
Max. Elev. / height	12° / 35 cm
Weight (1 pair)	13 kg
Max. load	300 kg
Folded size (LxWxH)	93 x 27 x 21 cm



The CH Ramps are hinged in the middle

Telescopic ramps type TR and LR

The ramps are made of aluminium with a friction surface. They consist of two separate drive-on rails with 3 segments which are provided with a locking mechanism to prevent unintentional extension and retraction of the segments.

The models "LR" are equipped with a convenient carrying case that can be attached to the wheelchair. The carrying case is also available for the TR model as an optional accessory (surcharge).

The telescopic ramps must be used in pairs



TR Ramps in use



TR Ramps folded for transport

Rampe TR/LR	TR-150	TR-210	TR-300	LR-150	LR-210
Length	150 cm	210 cm	300 cm	150 cm	210 cm
Width (per rail)	26 cm	26 cm	26 cm	16 cm	16 cm
Surface width	21 cm	21 cm	21 cm	11 cm	11 cm
Height of side protect.	7/5 cm	7/5 cm	7/5 cm	5,5/3 cm	5,5/3 cm
Max. Elev. / height	12° / 30 cm	12° / 42 cm	12° / 60 cm	12° / 30 cm	12° / 42 cm
Weight	2 x 5,5 kg	2 x 7,5 kg	2 x 9,5 kg	2 x 3 kg	2 x 4 kg
Max. load per pair	225 kg	225 kg	225 kg	180 kg	180 kg
Folded size cm (LxWxH)	74 x 26,5 x 7	95x26,5x7	125x26,5x7	74x16,5x5,5	95x6,5x5,5

Telescopic ramps type TM

The ramps are made of aluminium. The perforated lanes provide an ideal balance between weight and durability. In addition, the permeability is advantageous in rain, dirt or snow. The height of the side profile provides sufficient grip and directional stability. The TM-055 model consists of a pair of single rails, the TM-150 and TM-210 models consist of two telescopic segments each, the TM-300 model also has another folding element. The TM-150, TM-210 and TM-300 are secured in folded condition by a simple clip fastener.

The TM ramps must be used in pairs.



TM-055 ramp

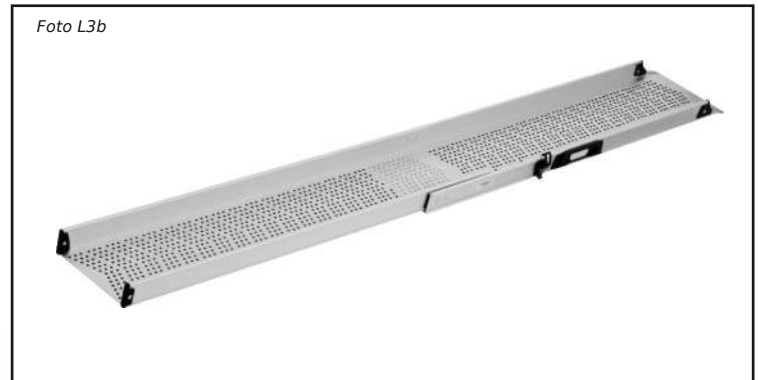

TM-150 ramp opened for use



TM-300 ramp folded



TM-300 ramp opened

TM Ramps	TM-055	TM-150	TM-210	TM-300
Length	55 cm	150 cm	210 cm	300 cm
Width (per rail)	25 cm	25 cm	25 cm	26 cm
Surface width	20 cm	20 cm	20 cm	20 cm
Height of side protect.	5,5 cm	5,5 cm	5,5 cm	5,5 cm
Max. Elevation / height	12° / 11 cm	12° / 30 cm	12° / 42 cm	12° / 60 cm
Weight	2 x 1,45 kg	2 x 3,95 kg	2 x 5,8 kg	2 x 8,65 kg
Max. load per pair	300 kg	300 kg	300 kg	250 kg
Folded size cm (LxWxH)	55 x 25 x 5,5	98 x 27x 9	128 x 27 x 9	108 x 26 x 13,5

Single-folded ramps type SF

The ramps are made of aluminium with a friction surface and are foldable in the longitudinal direction - a so-called flat-ramp. This offers the opportunity for volunteers to be able to stand on the ramp together with the wheelchair and the user. The ramps are equipped with a carrying handle and hinged at the middle, and they are portable like a suitcase. The model SF-040 is equipped with a convenient carrying bag that can be attached to the wheelchair.

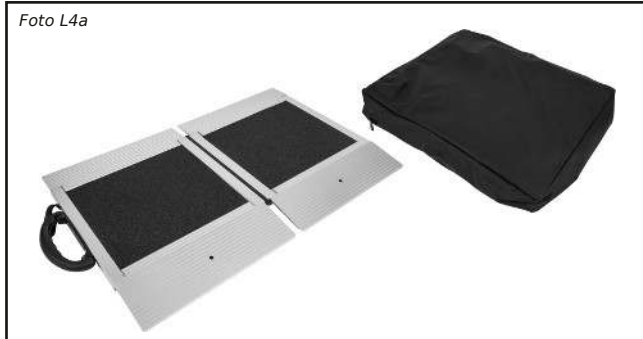

SF-040 Ramp in use (with bag)



SF-090 Ramp in use

SF Ramps	SF-040	SF-090	SF-120	SF-150
Length	40 cm	90 cm	120 cm	150 cm
Width (per rail)	71 cm	77 cm	77 cm	77 cm
Surface width	71 cm	73 cm	73 cm	73 cm
Height of side protect.	--	6 cm	6 cm	6 cm
Max. Elev. / height	12° / 10 cm	12° / 20 cm	12° / 25 cm	12° / 30 cm
Weight (1 pair)	4 kg	8 kg	10,5 kg	12,5 kg
Max. load	300 kg	300 kg	300 kg	300 kg
Folded size (LxWxH)	40 x 37 x 5 cm	90 x 40 x 10 cm	120 x 40 x 10 cm	150 x 40 x 10 cm

Single-folded ramps type SC

Inexpensive suitcase ramp in aluminium with anti slip surface. Hinged at the middle and carried like a suitcase. The model SC-045 is equipped with a convenient carrying bag that can be attached to the wheelchair.



SC Ramp in use



SC Ramp folded for transport

SC Ramps	SC-045	SC-060	SC-090	SC-120	SC-150	SC-180
Length	46 cm	62 cm	92 cm	122 cm	152 cm	182 cm
Width (per rail)	77 cm	77 cm	77 cm	77 cm	77 cm	77 cm
Surface width	76 cm	76 cm	76 cm	76 cm	76 cm	76 cm
Height of side protect.	3,5 cm	3,5 cm	3,5 cm	3,5 cm	3,5 cm	3,5 cm
Max. Elev. / height	12° / 10 cm	12° / 12 cm	12° / 20 cm	12° / 25 cm	12° / 30 cm	12° / 36 cm
Weight (1 pair)	4,50 kg	6,50 kg	9,00 kg	12,00 kg	15,00 kg	18,00 kg
Max. load	300 kg	300 kg	300 kg	300 kg	300 kg	300 kg
Folded size (LxWxH)	45x40x8	62x40x8	92x40x8	122x40x8	152x40x8	182x40x8

Double-folded ramps type DF

Made from aluminium and covered with a friction surface. Consists of 2 ramps that are hinged at the middle and carried like a suitcase.



DF Ramps in use



DF Ramps folded for transport

DF-Ramps	DF-180	DF-240	DF-300
<i>Length</i>	180 cm	240 cm	300 cm
<i>Width (per rail)</i>	79 cm	79 cm	79 cm
<i>Surface width</i>	75 cm	75 cm	75 cm
<i>Height of side protect.</i>	6 cm (innen)	6 cm (innen)	6 cm (innen)
<i>Max. Elev. / height</i>	12° / 36 cm	12° / 50 cm	12° / 60 cm
<i>Weight (1 pair)</i>	16 kg	22 kg	27,2 kg
<i>Max. load</i>	300 kg	300 kg	300 kg
<i>Folded size (LxWxH)</i>	91 x 36 x 19	124 x 40 x 19	154 x 40 x 19

Suitcase ramps type SR

Made from aluminium with a friction surface. Fourfold foldable one-piece ramp complete with carrier handle.



SR Ramp in use



SR Ramp folded for transport

SR-Ramps	SR-180	SR-240
<i>Length</i>	180 cm	240 cm
<i>Width</i>	75 cm	75 cm
<i>Surface width</i>	72 cm	72 cm
<i>Height of side protect.</i>	Outer side: 6 cm	Outer side: 6 cm
<i>Max. Elevation / height</i>	12° / 36 cm	12° / 48 cm
<i>Weight</i>	14,1 kg	18,5 kg
<i>Max. load</i>	300 kg	300 kg
<i>Folded size (L x W x H)</i>	102 x 28 x 38 cm	135 x 31 x 38 cm

Terrace ramps type T80

Terrace ramp made of aluminium with anti-slip pattern. The height is easily adjusted by loosening a bolt on each side. The ramp is designed so that it is placed on the ground - a permanent installation is not necessary. It is mounted so that it reaches the upper level of the threshold. Since it has no side-protection it is also possible to open the door while the ramp is in use.

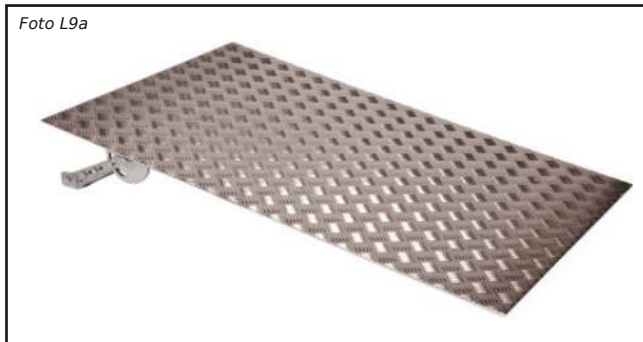

Terrace ramp



Height adjustment mechanism

Terrace Ramps	T80060	T80075	T80125
<i>Total length</i>	60 cm	75 cm	125 cm
<i>Width</i>	80 cm	80 cm	80 cm
<i>Max. superable height</i>	9 cm	13 cm	28 cm
<i>Total weight</i>	8,00 kg	12,00 kg	21,50 kg
<i>Max. Load</i>	225 kg	225 kg	225 kg
<i>Height adjustment</i>	5 - 9 cm	8 - 13 cm	11 - 28 cm

Doorstep ramp type TSR

Made of aluminium with anti-slip pattern. Suitable for terraces, entrances or in the garden. It can be height adjusted very precisely



TSR Ramp with opened flap



Height adjustment

TSR Ramps	TSR130	TSR140
<i>Total length (with opened flap)</i>	130 cm	140 cm
<i>Width</i>	80 cm	80 cm
<i>Width of flap</i>	75 cm	75 cm
<i>Size of flap</i>	30 x 75 cm	40 x 75cm
<i>Max. superable height</i>	20 cm	20 cm
<i>Total weight</i>	14,70 kg	15,60 kg
<i>Max. load</i>	225 kg	225 kg
<i>Height adjustment of the feet</i>	15 - 22,5 cm	15 - 22,5 cm

Carbon Ramp type CB

For mobile wheelchair ramps, weight and manageability play a very important role. Even the lightest aluminum can not always guarantee a low weight. Therefore we decided to use the lightest and most torsion-resistant material for the CB ramp series: Carbon Fiber.

Carbon fiber is extremely strong and reduces the weight by 30% compared to an aluminum ramp of the same size.

There is no better choice for an extremely light and agile wheelchair ramp.



Carbon Ramp CB-082

CB Carbon Ramp	CB-082
<i>Length</i>	82 cm
<i>Width (per rail)</i>	78 cm
<i>Max. Elev. / height</i>	16 cm
<i>Weight</i>	3 kg
<i>Max. load</i>	350 kg
<i>Folded size (LxW)</i>	82 x 39 cm

Mobilex A/S - Price list

All prices are per pcs. and in EUR.

07.2022

Leaflet L

Aluminium wheelchair ramps (for the ramps DF..., CH-180, TM, TR-... and LR-...the prices are for a pair)

Item nr.	Description	Foto	Price
CB-082	Singlefolded CB Carbon fiber ramp, including bag for wheelchair, 77 x 82 cm	L10A	1.001,00 €
CH-180	Channel-ramps, 23,5 cm x 180 cm, pairs	L1A	948,00 €
TR-150	Telescopic ramp TR 21 x 150 cm (Inside B x L), one pair	L2A	330,00 €
TR-210	Telescopic ramp TR 21 x 210 cm (Inside B x L), one pair	L2A	447,00 €
TR-300	Telescopic ramp TR 21 x 300 cm (Inside B x L), one pair	L2A	671,00 €
LR-150	Telescopic LR-150 ramp, 11 cm x 150 cm, pairs, incl. carry bag	L2A	245,00 €
LR-210	Telescopic LR-210 ramp, 11 cm x 210 cm, pairs, incl. carry bag	L2A	341,00 €
TM-055	Channel ramp TM-055, 20 x 55 cm, pairs	L3A	192,00 €
TM-150	Telescopic ramp TM, 20 cm x 150 cm (Inside B x L), two-part, pairs	L3B	426,00 €
TM-210	Telescopic ramp TM, 20 cm x 210 cm (Inside B x L), two-part, pairs	L3B	522,00 €
TM-300	Telescopic ramp TM, 20 cm x 300 cm (Inside B x L), three-part, pairs	L3C	809,00 €
SF-040	Singlefolded SF ramp 71 x 40 cm, with bag	L4A	320,00 €
SF-090	Singlefolded SF ramp 77 x 90 cm	L4B	469,00 €
SF-120	Singlefolded SF ramp 77 x 120 cm	L4B	618,00 €
SF-150	Singlefolded SF ramp 77 x 150 cm		724,00 €
SC-045	Single-folded ramp - SC-ramp 77 x 45 cm, incl. bag	L5A	202,00 €
SC-060	Single-folded SC ramp 77 x 60 cm	L5A	224,00 €
SC-090	Single-folded SC ramp 77 x 90 cm	L5A	256,00 €
SC-120	Single-folded SC ramp 77 x 120 cm	L5A	309,00 €
SC-150	Single-folded SC ramp 77 x 150 cm	L5A	362,00 €
SC-180	Single-folded SC ramp 77 x 180 cm	L5A	415,00 €
DF-180	Double-folded ramp 76 x 180 cm, pairs	L6A	1.129,00 €
DF-240	Double-folded ramp 76 x 240 cm, pairs	L6A	1.651,00 €
DF-300	Doublefolded ramp 76 x 300 cm, pairs	L6A	1.864,00 €
SR-180	Suitcase ramp SR-180, 76 x 180 cm	L7A	660,00 €
SR-240	Suitcase ramp SR-240, 76 x 240 cm	L7A	735,00 €
TSR130	Terrace ramp 80 x 100 cm with hinged part 30 cm	L8A	948,00 €
TSR140	Terrace ramp 80 x 100 cm with hinged part 40 cm	L8A	1.054,00 €
T80060	Terrace ramp T80060, 80 x 60 cm	L9A	469,00 €
T80075	Terrace ramp, T80075, 80 x 75 cm	L9A	511,00 €
T80125	Terrace ramp T80125, 80 x 125 cm	L9A	788,00 €

Accessories for aluminium wheelchair ramps

Item nr.	Description	Price
SB-060	Bag for SC-060 ramp	16,00 €
TB-150	Bag for TR-150 ramp	26,50 €
TB-210	Bag for TR-210 ramp	30,00 €
TB-300	Bag for TR-300 ramp	38,50 €
TK-060	Side for T80060 ramp	17,50 €
TK-125	Side for T80125 ramp	23,50 €
SC-001	Black Double Sided 3M Foam Tape, 350 x 50 x mm, for the support surface of all aluminium ramps	3,25 €

Spare parts for aluminium ramps

Item nr.	Description	Price
TR-003	1 set (8 pcs.) of black plastic endprotectors for TR-ramps	8,50 €
LR-001	1 set (4 pcs.) of black plastic endprotectors for LR-ramps	3,25 €
TR-004	Stop button for TR-ramps, black plastic with spring and brass bushing	8,50 €
TR-005	Handle for TR-ramps incl. rivets	21,50 €
TR150F	Friction paper for TR-150 ramp, pairs	32,00 €
TR210F	Friction paper for TR-210 ramp, pairs	42,50 €
TR300F	Friction paper for TR-300 ramp, pairs	53,00 €
TM-001	Lock for TM-ramps	10,50 €
TM-002	Lock for hinged part of TM-300 ramps	11,50 €
TM-003	Carrying handle for TM ramp	15,00 €
TM-004	End bracket for TM ramp black plastic set of 4 psc	23,50 €
SF9982	Friktionpaper for SF-090 ramp (set of 2 sheet)	53,00 €
SF9983	Friktionpaper for SF-120 ramp (set of 2 sheet)	64,00 €
SF9984	Friktion paper for SF-150 ramp (set of 2 sheet)	75,00 €
SF9991	Rubberhinge L = 740 mm for ramp SF-090 - 76 x 90 cm	12,50 €
SF9992	Rubberhinge L = 1040 mm for ramp SF-120 - 76 x 120 cm	15,50 €
SF9993	Rubberhinge L = 1340 mm for ramp SF-150 - 76 x 150 cm	19,50 €
SF9997	Rubber lock 115 x 25 mm for SF-ramps	5,00 €
SF9996	Rubber antislip support 85 x 345 mm for SF/DF ramps	5,50 €
SF9998	Plastic handle for SF/DF ramps - new model	9,75 €
SC-009	Hinge for SC-ramps	11,50 €
DF9981	Friktionpaper for DF-180 ramp (set of 4 sheet)	96,00 €
DF9982	Friktionpaper for DF-240 ramp (set of 6 sheet)	128,00 €
DF9983	Friktionpaper for DF-300 ramp (set of 6 sheet)	160,00 €
DF9971	Left, lower part of DF-240 ramp	266,00 €
DF9972	Right, lower part of DF-240 ramp	266,00 €
DF9973	Left, lower part of DF-300 ramp	447,00 €
DF9974	Right, lower part of DF-300 ramp	447,00 €
DF9975	Left, lower part of DF-180 ramp	341,00 €
DF9976	Right, lower part of DF-180 ramp	341,00 €
DF9985	Left, upper part of DF-240 ramp	341,00 €
DF9986	Right, upper part of DF-240 ramp	341,00 €
DF9987	Left, upper part of DF-300 ramp	469,00 €
DF9988	Right, upper part of DF-300 ramp	469,00 €
DF9989	Left, upper part of DF-180 ramp	277,00 €
DF9990	Right, upper part of DF-180 ramp	277,00 €
DF9991	Spring for connecting DF-ramps	10,50 €
DF9992	Locking device for DF-180 ramps	66,00 €
DF9993	Locking device for DF-240 / DF-300 ramps	58,00 €
DF9997	Plastic plug for ramp, right side (model SF-DF-CH)	2,25 €
DF9998	Plastic plug for ramp profiel, left side (model SF-DF-CH)	2,25 €
SR-501	Aluminium handle for SR-ramp	16,00 €
SR-502	Plastic end-capsules for SR-ramps	4,25 €
SR-505	Frictionpaper for SR-180 ramp, set with 4 pcs	51,00 €
SR-506	Frictionpaper for SR-240 ramp, set with 4 pcs	72,00 €
TSR501	Leg for TSR-ramp, for height 13-20 cm	64,00 €
TSR502	Leg for TSR-ramps, for height 16-22.5 cm	64,00 €

TRESHOLD RAMPS

THRESHOLD RAMPS

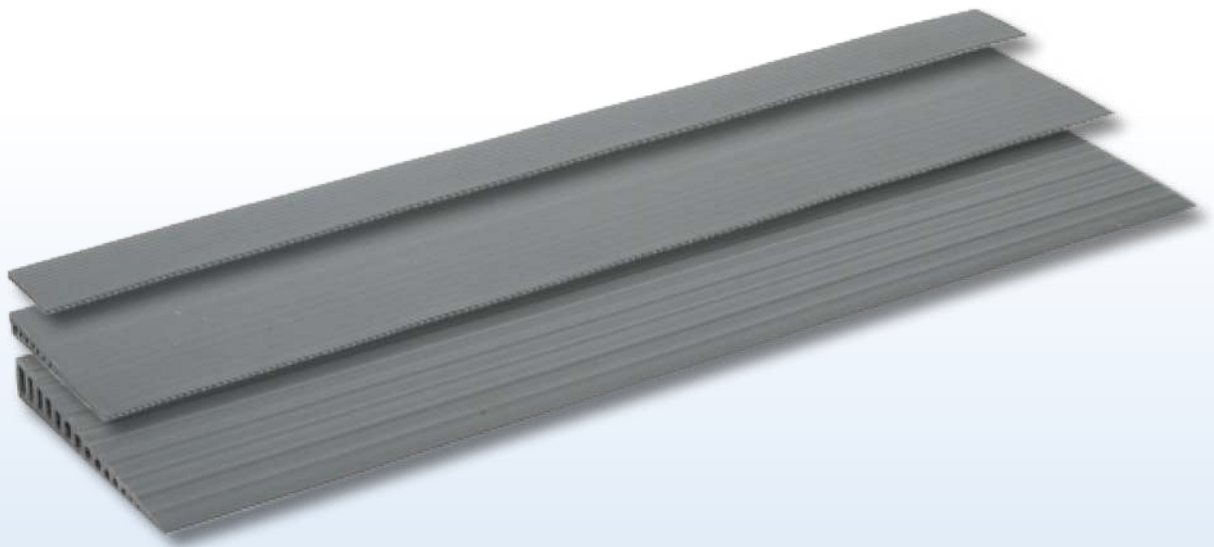

Leaflet LZ

Threshold ramps made of rubber
or aluminium, door rails

Doorstep ramps made of rubber

Rubber ramps with non-slip surface for example for use in bathrooms or outdoors. The ramps are made of rubber (TPE), they are PVC free and have an adhesive backing, but are also available without adhesive film. After removing the protective film, the ramp is ready for assembly right away. The ramps can easily be customized in width with a cutter or with the jigsaw blade (LX4) available as an accessory.



Foto LX1

The ramps are available in the following sizes:

4, 6, 8, 10, 12, 16, 20, 24, 28, 32, 36, 40, 44, 48, 52, 56, 60, 64, 68 and 72 mm

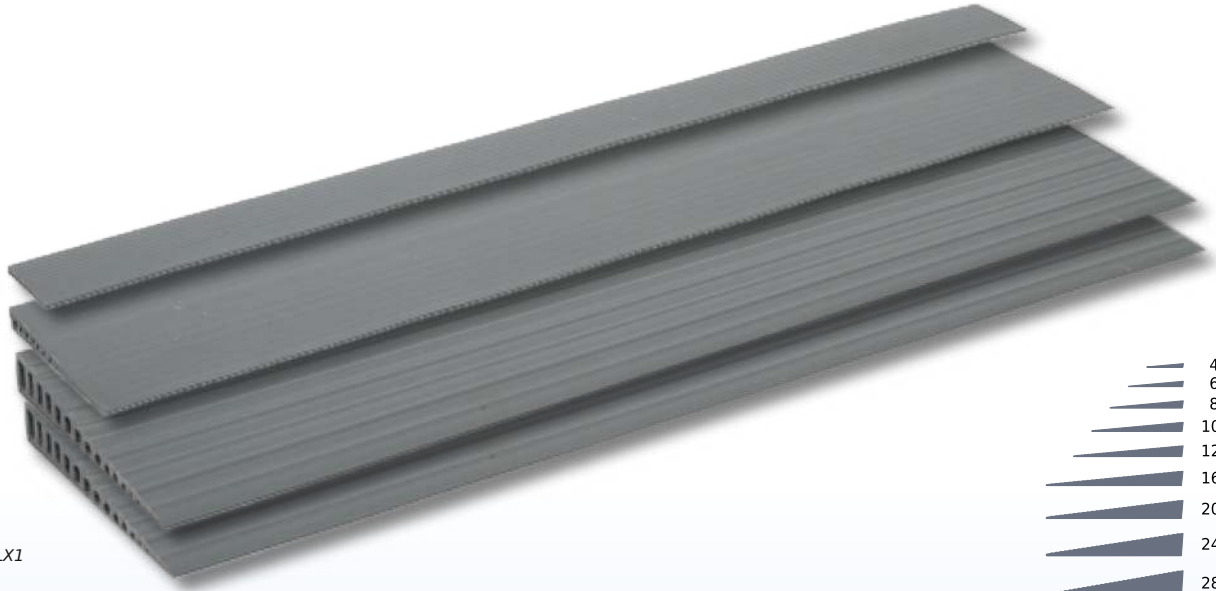

Foto LX1a

Function of the rubber ramp

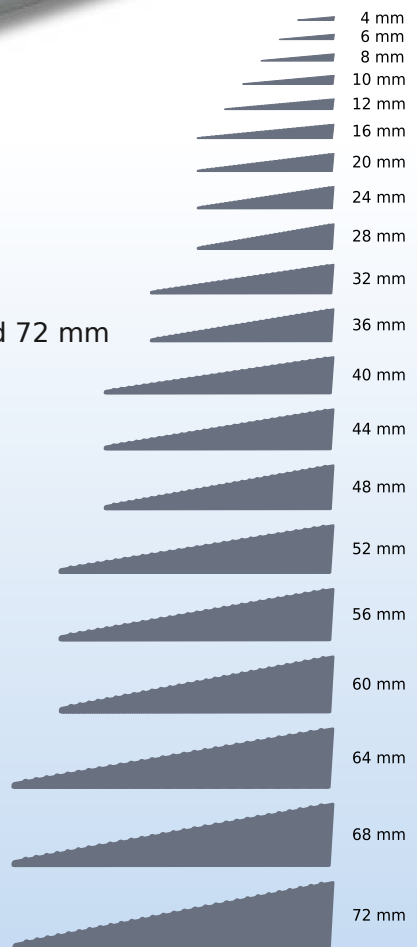

Foto LX1b

Rubber ramp in detail

Accessories for rubber ramps



Foto LX4

Jigsaw blade to cut the rubber ramps



Foto LX5

Double adhesive tape, 50 meters



Foto LX6

Double adhesive tape, 50 meters



Foto LX7

Fixating set for rubber ramps

Doorstep ramps and door rails made of aluminium

The **DS4076** and **DS4025** are folding threshold ramps made of aluminium with an anti-slip surface. The ramps have 2 milled handles and are equipped with a longitudinally running hinge for folding.



DS4076 folding threshold ramp made from aluminium



DS4025 threshold ramp, set of 2 hinged parts including a carrying bag

Technical data	DS4076	DS4025
Dimensions (L x W)	40 cm x 76 cm	40 cm x 25 cm (x 2)
Weight	3,3 kg	2 kg (as pair)
Max. Load	350 kg	350 kg

The **DS2176** is a mobile height adjustable threshold ramp in aluminium with an anti-slip surface. The 3 supplied feet are adjustable from 3 to 7 cm.



DS2176 threshold ramp made from aluminium



Feets for the height adjustment of the DS2176 ramp

Technical data	DS2176
Dimensions (L x W)	21 x 76 cm
Weight	1,55 kg
Max. Load	350 kg

Door rails made of aluminium

Made from champagne or silver anodized aluminium.

Door rails can be fitted to close the gap when the doorstep is removed.

Available in 3 sizes : 125 mm, 150 mm, 175 mm.



Door rail made from anodized aluminium

Rubber ramps with glue, L=700 mm

Item nr.	Description (H x L x W)	Foto	PU *	Price
30610L	Rubberramp, grey, with glue, 10 x 100 x 700 mm	LX1	10	22,50 €
30612L	Rubberramp, grey, with glue, 12 x 120 x 700 mm	LX1	10	25,50 €
30616L	Rubberramp, grey, with glue, 16 x 150 x 700 mm	LX1	10	31,00 €
30620L	Rubberramp, grey, with glue, 20 x 150 x 700 mm	LX1	10	44,50 €
30624L	Rubberramp, grey, with glue, 24 x 150 x 700 mm	LX1	10	55,00 €
30628L	Rubberramp, grey, with glue, 28 x 200 x 700 mm	LX1	5	72,00 €
30632L	Rubberramp, grey, with glue, 32 x 200 x 700 mm	LX1	5	75,00 €
30636L	Rubberramp, grey, with glue, 36 x 200 x 700 mm	LX1	5	81,00 €
30640L	Rubberramp, grey, with glue, 40 x 250 x 700 mm	LX1	5	89,00 €
30644L	Rubberramp, grey, with glue, 44 x 250 x 700 mm	LX1	5	98,00 €
30648L	Rubberramp, grey, with glue, 48 x 250 x 700 mm	LX1	5	107,00 €

Rubber ramps with glue, L=900 mm

Item nr.	Description (H x L x W)	Foto	PU *	Price
306040	Rubberramp, grey, with glue, 4 x 40 x 900 mm	LX1	10	6,50 €
306060	Rubberramp, grey, with glue, 6 x 60 x 900 mm	LX1	10	19,00 €
306080	Rubberramp, grey, with glue, 8 x 80 x 900 mm	LX1	10	21,50 €
306100	Rubberramp, grey, with glue, 10 x 100 x 900 mm	LX1	10	29,00 €
306120	Rubberramp, grey, with glue, 12 x 120 x 900 mm	LX1	10	32,00 €
306160	Rubberramp, grey, with glue, 16 x 150 x 900 mm	LX1	10	38,50 €
306200	Rubberramp, grey, with glue, 20 x 150 x 900 mm	LX1	10	55,00 €
306240	Rubberramp, grey, with glue, 24 x 150 x 900 mm	LX1	10	69,00 €
306280	Rubberramp, grey, with glue, 28 x 200 x 900 mm	LX1	5	89,00 €
306320	Rubberramp, grey, with glue, 32 x 200 x 900 mm	LX1	5	94,00 €
306360	Rubberramp, grey, with glue, 36 x 200 x 900 mm	LX1	5	102,00 €
306400	Rubberramp, grey, with glue, 40 x 250 x 900 mm	LX1	5	111,00 €
306440	Rubberramp, grey, with glue, 44 x 250 x 900 mm	LX1	5	119,00 €
306480	Rubberramp, grey, with glue, 48 x 250 x 900 mm	LX1	5	126,00 €
306520	Rubberramp, grey, with glue, 52 x 300 x 900 mm	LX1	2	162,00 €
306560	Rubberramp, grey, with glue, 56 x 300 x 900 mm	LX1	2	187,00 €
306600	Rubberramp, grey, with glue, 60 x 300 x 900 mm	LX1	2	211,00 €
306640	Rubberramp, grey, with glue, 64 x 350 x 900 mm	LX1	2	235,00 €
306680	Rubberramp, grey, with glue, 68 x 350 x 900 mm	LX1	2	259
306720	Rubberramp, grey, with glue, 72 x 350 x 1000 mm	LX1	2	283

Rubber ramps without glue, L=900 mm

Item nr.	Description (H x L x W)	Foto	PU *	Price
306041	Rubberramp, grey, without glue, 4 x 40 x 900 mm	LX1	10	5,25 €
306061	Rubberramp, grey, without glue, 6 x 60 x 900 mm	LX1	10	16,00 €
306081	Rubberramp, grey, without glue, 8 x 80 x 900 mm	LX1	10	17,00 €
306101	Rubberramp, grey, without glue, 10 x 100 x 900 mm	LX1	10	23,50 €
306121	Rubberramp, grey, without glue, 12 x 120 x 900 mm	LX1	10	26,50 €
306161	Rubberramp, grey, without glue, 16 x 150 x 900 mm	LX1	10	32,00 €
306201	Rubberramp, grey, without glue, 20 x 150 x 900 mm	LX1	10	47,00 €
306241	Rubberramp, grey, without glue, 24 x 150 x 900 mm	LX1	10	60,00 €
306281	Rubberramp, grey, without glue, 28 x 200 x 900 mm	LX1	5	79,00 €
306321	Rubberramp, grey, without glue, 32 x 200 x 900 mm	LX1	5	83,00 €
306361	Rubberramp, grey, without glue, 36 x 200 x 900 mm	LX1	5	92,00 €
306401	Rubberramp, grey, without glue, 40 x 250 x 900 mm	LX1	5	104,00 €
306441	Rubberramp, grey, without glue, 44 x 250 x 900 mm	LX1	5	113,00 €
306481	Rubberramp, grey, without glue, 48 x 250 x 900 mm	LX1	5	119,00 €
306521	Rubberramp, grey, without glue, 52 x 300 x 900 mm	LX1	2	155,00 €
306561	Rubberramp, grey, without glue, 56 x 300 x 900 mm	LX1	2	179,00 €
306601	Rubberramp, grey, without glue, 60 x 300 x 900 mm	LX1	2	200,00 €
306641	Rubberramp, grey, without glue, 64 x 350 x 900 mm	LX1	2	221,00 €
306681	Rubberramp, grey, without glue, 68 x 350 x 900 mm	LX1	2	242,00 €
306722	Rubberramp, grey, without glue, 72 x 350 x 1000 mm	LX1	2	274,00 €

* PU = Packaging unit (the items are also available individually)

Rubber ramps with glue, L=1000 mm

Item nr.	Description (H x L x W)	Foto	PU *	Price
306042	Rubberramp, grey, with glue, 4 x 40 x 1000 mm	LX1	10	7,50 €
306062	Rubberramp, grey, with glue, 6 x 60 x 1000 mm	LX1	10	21,50 €
306082	Rubberramp, grey, with glue, 8 x 80 x 1000 mm	LX1	10	24,50 €
306102	Rubberramp, grey, with glue, 10 x 100 x 1000 mm	LX1	10	32,00 €
306122	Rubberramp, grey, with glue, 12 x 120 x 1000 mm	LX1	10	36,00 €
306162	Rubberramp, grey, with glue, 16 x 150 x 1000 mm	LX1	10	46,00 €
306202	Rubberramp, grey, with glue, 20 x 150 x 1000 mm	LX1	10	66,00 €
306242	Rubberramp, grey, with glue, 24 x 150 x 1000 mm	LX1	10	80,00 €
306283	Rubberramp, grey, with glue, 28 x 200 x 1000 mm	LX1	5	100,00 €

Rubber ramps without glue, L=1000 mm

Item nr.	Description (H x L x W)	Foto	PU *	Price
306282	Rubberramp, grey, without glue, 28 x 200 x 1000 mm	LX1	5	87,00 €
306322	Rubberramp, grey, without glue, 32 x 200 x 1000 mm	LX1	5	92,00 €
306362	Rubber ramp, grey, without glue, 36 x 200 x 1000 mm	LX1	5	98,00 €
306402	Rubberramp, grey, without glue, 40 x 250 x 1000 mm	LX1	5	111,00 €
306442	Rubberramp, grey, without glue, 44 x 250 x 1000 mm	LX1	5	119,00 €
306482	Rubberramp, grey, without glue, 48 x 250 x 1000 mm	LX1	5	124,00 €
306522	Rubberramp, grey, without glue, 52 x 300 x 1000 mm	LX1	2	166,00 €
306562	Rubberramp, grey, without glue, 56 x 300 x 1000 mm	LX1	2	190,00 €
306602	Rubberramp, grey, without glue, 60 x 300 x 1000 mm	LX1	2	211,00 €
306642	Rubberramp, grey, without glue, 64 x 350 x 1000 mm	LX1	2	232,00 €
306682	Rubberramp, grey, without glue, 68 x 350 x 1000 mm	LX1	2	253,00 €
306722	Rubberramp, grey, without glue, 72 x 350 x 1000 mm	LX1	2	274,00 €

Accessories for rubber ramps

Item nr.	Description (H x L x W)	Foto	PU *	Price
306904	Jigsaw blade for rubber ramp	LX4	1	18,00 €
306911	Double adhesive tape, width 20 mm, length 50 meter	LX5	1	26,50 €
306912	Double adhesive tape, width 35 mm, length 50 meter	LX5	1	37,50 €
306905	Degreaser for removal of glue 1/2 L	LX6	1	36,00 €
306910	Mounting set for rubber ramp zinc plated, 28-78 mm height	LX7	1	10,50 €

Aluminium threshold ramps

Item nr.	Description (H x L x W)	Foto	PU *	Price
DS4025	Doorstep ramp 1-5 x 40 x 25 cm (H x D x L), 2 psc foldable	LX8B	1	128,00 €
DS4076	Doorstep ramp 1-5 x 40 x 76 cm (H x D x L), foldable	LX8A	1	144,00 €
DS2176	Doorstep ramp 3-7 x 21 x 76 cm (H x B x L)	LX9	1	96,00 €

Aluminium door rails, champagne or silver anodised

Item nr.	Description (H x L x W)	Foto	PU *	Price
307125	Doorrail 3 x 125 x 900 mm, champagne anodised	LX10	1	38,50 €
307150	Doorrail 3 x 150 x 900 mm, champagne anodised	LX10	1	47,00 €
307175	Doorrail 3,5 x 175 x 900 mm, champagne anodised	LX10	1	55,00 €

308100	Doorrail 3 x 100 x 1000 mm, silver anodised	LX10	1	36,00 €
308125	Doorrail 3 x 125 x 1000 mm, silver anodised	LX10	1	42,50 €
308150	Doorrail 3 x 150 x 1000 mm, silver anodised	LX10	1	51,00 €
308175	Doorrail 3 x 175 x 1000 mm, silver anodised	LX10	1	58,00 €
308200	Doorrail 3,5 x 200 x 1000 mm, silver anodised	LX10	1	66,00 €

* **PU** = Packaging unit (the items are also available individually)

THE THERAPY TABLE

THE THERAPY TABLE



Leaflet M

Therapy tables for wheelchairs

Universal therapy table made of transparent PETG

Therapy table that is made from 6 mm transparent, impact resistant PETG, with 3 side protectors, and adjustable up to 9 cm in the width. To be fitted on the armrest upholstery. Adjustable from 28 to 58 mm polstering height, for thinner armrests adapters are available. The adapter can also adjust the width of the wheelchair (max. 9 cm).



Universal therapy table



XL Therapy table



Detail

Available for 3 widths (external distance between the armrests):

- ✓ 460 - 550 mm (seat width of approx. 36-45 cm)
- ✓ 530 - 620 mm (seat width of approx. 43-52 cm)
- ✓ 600 - 690 mm (seat width of approx. 50-59 cm)

Universal half-side therapy table made of transparent PETG

Half-side therapy table made of 8 mm transparent impact resistant PETG. To be fitted on the armrest upholstery. Adjustable from 28 to 58 mm upholstery height, for thinner armrests adapters are available. The adapter can also adjust the width of the wheelchair (max. 9 cm).



Half-side therapy table in use



Half-side therapy table not in use

Universal therapy table with Velcro stripes

Universal therapy table that is made from 4 mm transparent and impact resistant PETG with 3 side railings. It is fixed to the armrests of the wheelchair with 2 Velcro stripes.



Therapy table with Velcro stripes

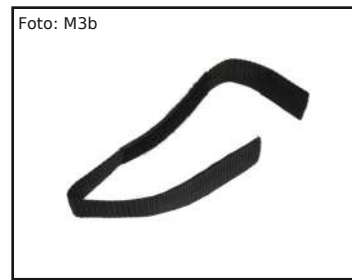

Velcro stripe

Available for 3 widths (external distance between the armrests):

- ✓ 505 - 549 mm (seat width of approx. 40 cm)
- ✓ 555 - 549 mm (seat width of approx. 45 cm)
- ✓ 605 - 549 mm (seat width of approx. 50 cm)

Universal mounting system for fold-down therapy tables

Universal mounting system made of chrome-plated steel for fold-down therapy tables. The system is supplied without table top and consists of the bracket and the armrest fitting, which are supplied separately. For a complete system, both parts must be ordered.



Bracket for fold-down therapy tables



Armrest fitting for fold-down therapy tables

Therapy tables

Item nr.	Description	for ca. SW	Foto	Price
240002	Universal height- and width adjustable therapy table, 46-55 cm	36 – 45 cm	M1A	100,00 €
240003	Universal height- and width adjustable therapy table, 53-62 cm	43 – 52 cm	M1A	104,00 €
240004	Universal height- and width adjustable therapy table, 60-69 cm	50 – 59 cm	M1B	132,00 €

240061	Halfside table, left side	--	M1D	126,00 €
240062	Halfside table, right side	--	M1D	126,00 €

240081	Therapy table 505 x 549 x 4 mm, with Velcro, for seat width 40 cm	40,0 cm	M3A	100,00 €
240083	Therapy table 555 x 549 x 4 mm, with Velcro, for seat width 45 cm	45,0 cm	M3A	102,00 €
240086	Therapy table 605 x 549 x 4 mm, with Velcro, for seat width 50 cm	50,0 cm	M3A	194,00 €

Spare parts for therapy tables

Item nr.	Description	Foto	Price
240007	Chrome-plated steel armrest fitting for fold-down therapy tables	M2D	30,00 €
240008	Bracket made of chrome-plated steel for folding therapy tables	M2C	87,50 €

240009	Rails for therapy table incl. bolt and bushings	M1B	49,00 €
240010	Bolt for therapy table M6 x 50 mm	M1B	6,50 €
240011	Handle for therapy table M6 x 35 mm	M1B	6,50 €

240091	Plate in PETG 612 x 515 mm for 240002	M1A	85,00 €
240092	Plate in PETG 680 x 545 mm for 240003	M1A	92,00 €
240093	Plate in PETG 770 x 515 mm for 240004	M1A	128,00 €

240069	Distance plate 220 x 28 x10 mm (L x W x H) for halfsite wheelchair table	M2A	10,50 €
--------	--	-----	---------

240015	Velcro strap for wheelchair tables	M3B	2,25 €
--------	------------------------------------	-----	--------

GRAB BARS

GRAB BARS

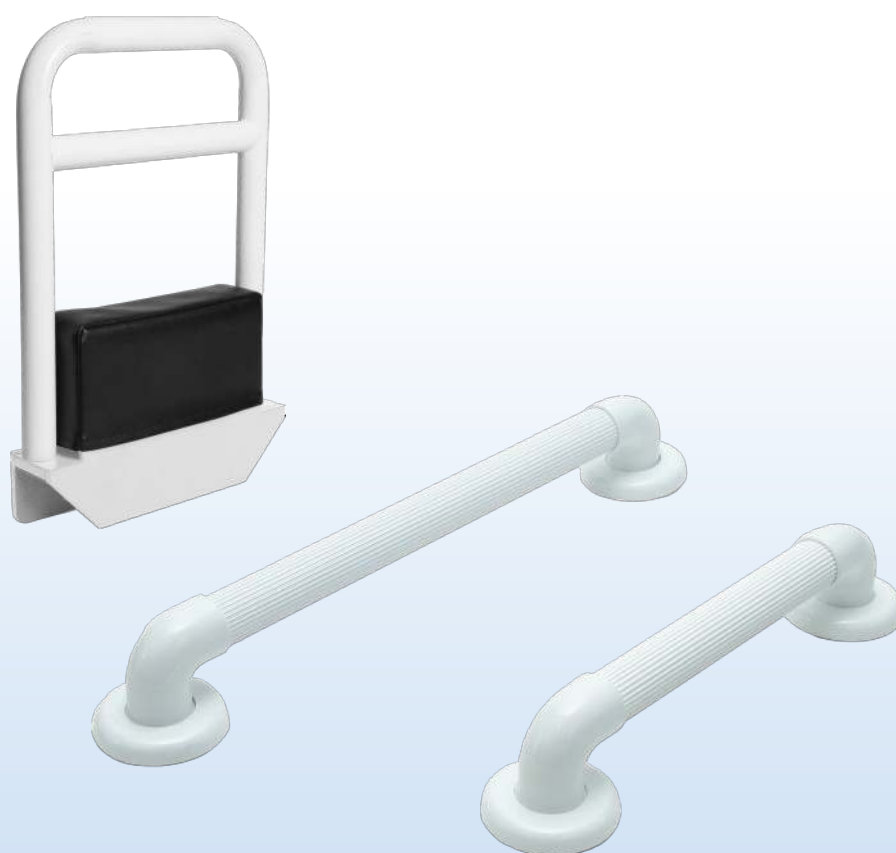

Leaflet N

Grab bars and support handles made of ABS or steel

Grab bars made of white PVC with longitudinally grooved grip surface

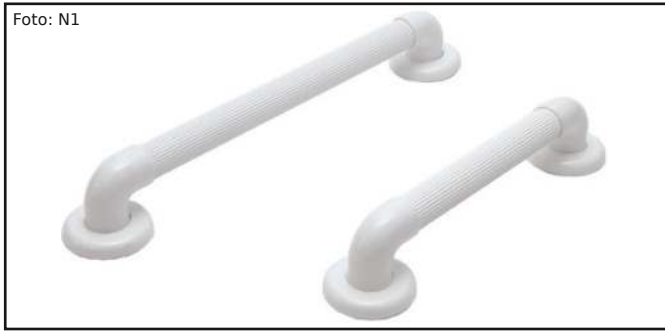

Grab bar with ribbed surface

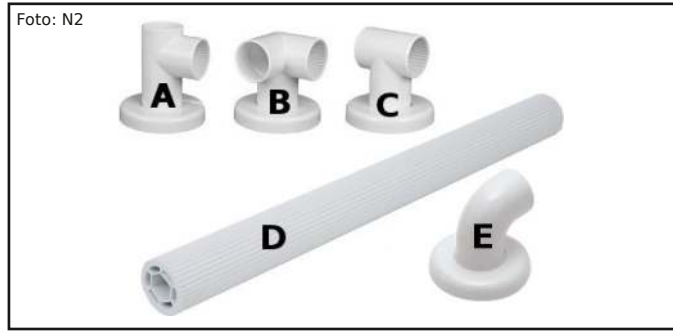

Plastic connection joints and tube

The grab bars have a diameter of 36 mm and fit very well in the hand. They are easy to clean. Special end and extension pieces for mounting in angles and corners (picture N2) are available. The straight PVC grab bars are available in the following lengths: 30 cm, 45 cm and 60 cm. The max. load capacity is 120 kg depending on the type of wall.

Grab bars from steel



Grab bars from steel coated with white Rilsan®

The steel grab bars are coated with white Rilsan® and are available in lengths of 16, 25, 30, 40, 50, 60, 75 or 90 cm. The grab bars all have a diameter of 25 mm, but the 16 cm bar has a diameter of 20 mm. The max. load is up to 150 kg depending on the type of wall.

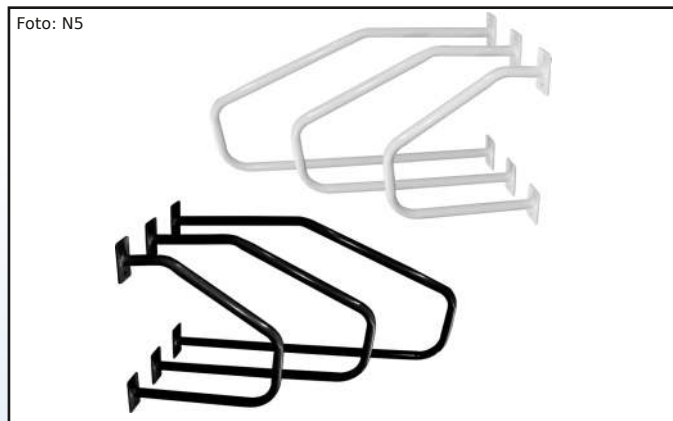

Support handles from steel

The support handles are made of a white or black powder-coated steel tube with a diameter of 25 mm. The support handles provide additional balance support and can be used indoors and outdoors (e.g. on the wall next to the toilet or as a handrail on the front door). Length: 40 cm, 60 cm or 80 cm.

Folding support rail for the bathroom



Foldable support rail for wall mounting

The folding support rail made of white coated steel ensures safety and comfort for disabled persons during their daily activities in the toilet or bathroom.

Length: 55 cm or 76 cm
Handrail's diameter: 3,2 cm
Max. user weight: 120 kg

Universal bed support



Bed support

The universal bed support handle made of powder coated steel is an aid for getting up and for relocating, which is clamped to the bed side wall.

The handle is suitable for bed side walls with a thickness of 20-50 mm.

Handle height: 330 mm

Handle width: 195 mm

Weight: 4.7 kg

Bed support handle for the bed frame



Bed support handle with robust base



The support handle folded

Bed support handles are the solution for anyone who has difficulty getting in and out of bed on their own. Made of aluminium with a robust base, it is simply placed on the bed frame and secured with 2 straps.

This way it stays securely in place without slipping. The ergonomically shaped handle offers maximum safety when getting up. The bed support handle is mounted and ready for use in no time at all.

Handle length (height): 547 mm

Weight: 3.3 kg

Grabbars- und Stützgriffendes

Art.Nr.	Beschreibung	Bild	VK	EK	10'er
311230	Plastikgriff, farbe Weiss, gerillt, 30 cm	N1	9,50 €	5,70 €	9,50 €
311245	Plastikgriff, farbe Weiss, gerillt, 45 cm	N1	11,50 €	6,90 €	11,50 €
311260	Plastikgriff, farbe Weiss, gerillt, 60 cm	N1	14,50 €	8,70 €	14,50 €
311291	Endstück für Haltegriffe	N2E	3,25 €	1,95 €	3,25 €
311292	Rohr, gerillt, 100 cm für Haltegriffe	N2D	13,50 €	8,10 €	13,50 €
311293	Endstück für Haltegriffe, 90 Grad Eck	N2B	3,25 €	1,95 €	3,25 €
311294	Endstück für Haltegriffe, durchgehend	N2C	3,25 €	1,95 €	3,25 €
311295	Endstück für Haltegriffe, senkrechter Winkel	N2A	3,25 €	1,95 €	3,25 €
311316	Haltegriff, weiss, mit Rilsanbeschichtung, 16 cm	N3	14,00 €	8,40 €	14,00 €
311325	Haltegriff, weiss, mit Rilsanbeschichtung, 25 cm	N3	17,00 €	10,20 €	17,00 €
311330	Haltegriff, weiss, mit Rilsanbeschichtung, 30 cm	N3	18,00 €	10,80 €	18,00 €
311340	Haltegriff, weiss, mit Rilsanbeschichtung, 40 cm	N3	21,50 €	12,90 €	21,50 €
311350	Haltegriff, weiss, mit Rilsanbeschichtung, 50 cm	N3	23,50 €	14,10 €	23,50 €
311360	Haltegriff, weiss, mit Rilsanbeschichtung, 60 cm	N3	25,50 €	15,30 €	25,50 €
311375	Haltegriff, weiss, mit Rilsanbeschichtung, 75 cm	N3	32,00 €	19,20 €	32,00 €
311390	Haltegriff, weiss, mit Rilsanbeschichtung, 90 cm	N3	40,50 €	24,30 €	40,50 €
311335	Haltegriff, schwarz pulverlackiert, 30 cm	N3	17,00 €	10,20 €	17,00 €
311335	Grab bar, black powder coated, 30 cm	N3			17,00 €
311440	Stützgriff 40 cm, schwarz pulverlackiert, Wandmontage, 4 Löcher	N5	41,50 €	24,90 €	41,50 €
311460	Stützgriff 60 cm, schwarz pulverlackiert, Wandmontage, 4 Löcher	N5	44,50 €	26,70 €	44,50 €
311480	Stützgriff 80 cm, schwarz pulverlackiert, Wandmontage, 4 Löcher	N5	48,00 €	28,80 €	48,00 €
311440	Stützgriff 40 cm, weiss pulverlackiert, Wandmontage, 4 Löcher	N5	41,50 €	24,90 €	41,50 €
311560	Stützgriff 60 cm, weiss pulverlackiert, Wandmontage, 4 Löcher	N5	44,50 €	26,70 €	44,50 €
311580	Stützgriff 80 cm, weiss pulverlackiert, Wandmontage, 4 Löcher	N5	48,00 €	28,80 €	48,00 €
311580	Support rail 80 cm, white powder coated, with 4 holes	N5			48,00 €
311655	Klappbare Stützschiene, weiß, 55 cm, Wandmontage, 6 Löcher	N6	55,00 €	33,00 €	55,00 €
311675	Klappbare Stützschiene, weiß, 76 cm, Wandmontage, 6 Löcher	N6	62,00 €	37,20 €	62,00 €
311676	Wall mounted folding support rail, white, 76 cm, with 6 holes	N6			62,00 €
311805	Bettstützgriff zum Festklemmen	N4	198,00 €	118,80 €	198,00 €
311805	Bed support handle to clamp on	N7A	94,00 €	56,40 €	94,00 €
311815	Bed lever, for the bed frame	N7A			94,00 €
311806	Abstandsblock für Bett-Stützgriff	N5	20,00 €	12,00 €	20,00 €
311806	Distance block for bed support	N5	9,50 €	5,70 €	9,50 €
311807	Fabric cover for bed support	N5			9,50 €
311097	Montagesatz (4 Schrauben 8 x 80 mm mit weissen Abdeckkappen, 4 Dübel, 4 Unterlegscheiben)	N3	8,75 €	5,25 €	8,75 €
311097	Mounting kit (4 screws 8 x 80 mm with white caps, 4 dowels, 4 washers)	N3			8,75 €
311099	Montagesatz (4 Schrauben 8 x 80 mm mit schwarzen Abdeckkappen, 4 Dübel, 4 Unterlegscheiben)	N3	8,75 €	5,25 €	8,75 €
311099	Mounting kit (4 screws 8 x 80 mm with black caps, 4 dowels, 4 washers)	N3			8,75 €
311098	Montagesatz (6 Schrauben 8 x 80 mm mit weissen Abdeckkappen, 6 Dübel, 6 Unterlegscheiben)	N3	13,00 €	7,80 €	13,00 €
311098	Mounting kit (6 screws 8 x 80 mm with white caps, 6 dowels, 6 washers)	N3			13,00 €
311497	Montageplatte schwarz 150 x 100 x 8 mm, 2 x M8 Gewinde, 6 Montagelöcher ø9 mm	N3	19,00 €	11,40 €	19,00 €
311497	Mounting plate black 150 x 100 x 8 mm with 2 pcs. m8 thread holes and 6 pcs. ø9 holes	N3			19,00 €
311597	Montageplatte weiss 150 x 100 x 8 mm, 2 x M8 Gewinde, 6 Montagelöcher ø9 mm	N3	19,00 €	11,40 €	19,00 €
311597	Mounting plate white 150 x 100 x 8 mm with 2 pcs. m8 thread holes and 6 pcs. ø9 holes	N3			19,00 €

BATHING PRODUCTS

BATHING PRODUCTS



Leaflet OX

Bathing products: Shower stools, shower chairs,
bathtub seats and bath boards

AQUA

ALUMINIUM SHOWER STOOL



1

The optional backrest, like the seat, is made of soft PUR and can be easily adjusted in depth.

2

Comes standard with a soft PUR seat that provides extra pressure relief and comfort.

3

During the development of the armrests, the focus was placed on ergonomics to make it easier to stand up.

4

The legs can be easily adjusted in height with clips and without tools. The pin of the clips is made of stainless steel.

5

Despite its high load-bearing capacity, the shower stool has a low dead weight and can be stacked easily

6

The welded aluminium construction provides a lightweight and stable frame for safe use.

AQUA shower stool of aluminium



Shower stool, grey, with soft PU seat



Optional back for shower stool

Shower stool in aluminium with soft seat in grey PUR, seat height adjustable. Also available in white aluminium, with grey soft PUR seat. Available as accessory: soft backrest that can be mounted without tools.

A backrest with a soft grey back is available as an accessory for the shower stool. The backrest is attached to the stool by means of clips. Available in the frame colours white or grey.

AQUA Shower chair	Small (302070+71)	Standard (302072+73)	Large (302078+79)	XL (30207X)
Size (W x D x H)	51,5 x 53,5 x 41,7-58,5 cm	56,5 x 53,5 x 41,7-58,5 cm	62,5 x 53,5 x 41,7-58,5 cm	68,5 x 53,5 x 41,7-58,5 cm
Seat size (W x D)	40,7 x 33,5 cm	45,2 x 33,5 cm	50 x 33,5 cm	50 x 33,5 cm
Inner width	42 cm	47 cm	52 cm	57 cm
Seat height	41,7 - 58,5 cm	41,7 - 58,5 cm	41,7 - 58,5 cm	41,7 - 58,5 cm
Armrest height	60,4 - 77,1 cm	60,4 - 77,1 cm	60,4 - 77,1 cm	60,4 - 77,1 cm
Weight	2,7 kg	2,9 kg	3,3 kg	3,86
Max. user weight	150 kg	150 kg	200 kg	250 kg

Free-standing support for the WC



Free-standing support for the WC or bidet

The free-standing and height-adjustable support is intended as an aid for people who need support when sitting or standing up from the WC or bidet.

The frame is made of aluminium and is corrosion-resistant. The support can be adjusted in width and height to fit most toilets and requires no installation or tools and is easy to adjust using clips.

Dimensions	302090
Size (W x D x H)	46-52 x 53-61 x 61-78 cm
Inner width	44 - 49 cm
Armrest height	61,6 - 78,6 cm
Weight	1,88 kg
Max. user weight	150 kg

Bathtub seat

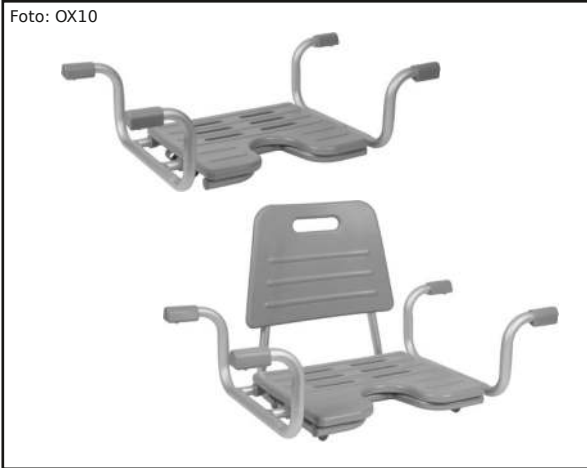

Bathtub seat, grey with soft PU seat

Bathtub seat with hygiene cut-away. Silver-coloured aluminium frame. Seat and backrest (optional) of soft grey PU. The optional backrest is fixed with clips and is easily removable.

Swivel bather



Swivel bather, grey with soft PU seat

Swivel bather with hygiene cut-away. Silver-coloured aluminium frame. Seat and backrest are made of soft grey PU. The backrest and the armrests are fixed with clips and are easily removable.

Bathtub seats	Fixed	Swivel bather
Dimensions W x D x H	76-91 x 42 x 23 cm	71 x 54 x 57 cm
Seat size D x D	41 x 34 cm with cut-away	
Heights	Armrests: 20 cm - Backrest: 38 cm	
For bathtubs	57 to 66 cm (inner width)	
Weight	2,6 kg	4,88 kg
Max. load	150 kg	130 kg

Foldable shower chair



Foldable shower chair

The frame is made of white coloured aluminium and the chair has an ergonomic seat with cutaway for better personal hygiene.

Foldable shower chair with WC



Foldable shower chair with WC

The frame is made of white coloured aluminium and the chair has a removable toilet bucket with lid and carrying handle.

Wall mounted shower chair



Wall mounted shower chair

Wall mounted shower chair with cut-away for better personal hygiene.

Technical Data	Foldable shower-chair	Foldable shower-chair with WC	Wall mounted shower-chair
Total size (WxDxH)	55,5 x 51 x 80-90 cm	55,5 x 51 x 80-90 cm	44 x 54,5 x 43,5-51 cm
Folded size (WxDxH)	55,5 x 17 x 80 cm	55,5 x 17 x 80 cm	44 x 11 x 45 cm
Height adjustable	80 - 90 cm	80 - 90 cm	43,5 - 51 cm
Seat-height adjust.	46 - 56 cm	46 - 56 cm	43,5 - 51 cm
Weight	4,05 kg	4,85 kg	3,5 kg
Max. load	100 kg	100 kg	100 kg

Round shower chair

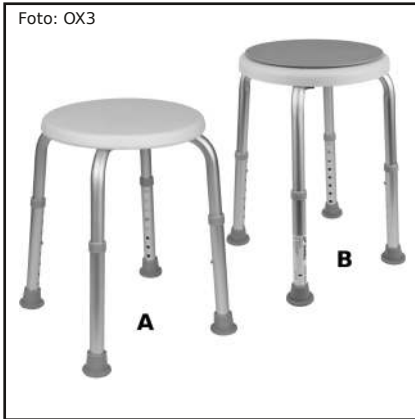

Round shower chair with fixed seat (A) or swivel seat (B)

Aluminium shower chair with round fixed seat (a) or with an additional swivel seat (B). Both chairs are adjustable in height.

Triangular shower chair

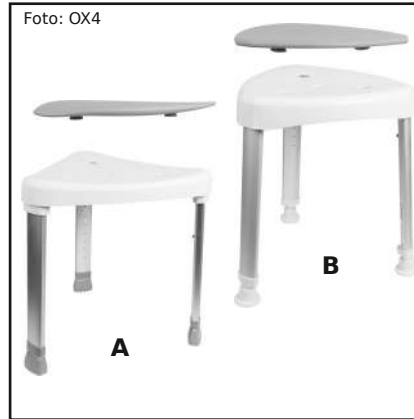

Triangular shower chair with soft seat cushion as accessory

Aluminium shower chair with triangular white plastic seat (A), adjustable in height. A soft seat cushion is available optionally (B).

Budget shower chair



Budget shower chair

Budget shower chair with aluminium frame and a white plastic seat with 2 lateral handles. The shower chair is adjustable in height.

Shower stool	Round			Triangular	
	302064	302063	302066	302067	302069
Seat size / swivel	ø 33 cm / ---		ø 33,0 / 29,6 cm	43,0 x 44,0 cm	33,0 x 35,0 cm
Height adjustable	35,5 - 53,5 cm		34,7 - 52,5 cm	47,0 - 64,6 cm	45,5 - 55,5 cm
Weight	1,5 kg		1,62 kg	2,62 kg	2,15 kg
Max. load	130 kg		130 kg	150 kg	120 kg

Sliding bathtub seat



Sliding bathtub seat

The Mobilex sliding bathtub seat has a frame made of aluminium. The seat, the back and the soap holder are made of white plastic.

A red handle is attached on the seat, which, like the soap holder can be attached to the left or right side of the sliding seat.

The seat is height adjustable and mounted on roller bearings so when using the handle it can be pushed slightly above the bathtub wall.

Technical data	Sliding bathtub seat
Width	107 - 111 cm
Depth	49 - 53 cm
Total height	89,6 - 99,5 cm
Seat dimensions (L x D)	50 x 39,5 cm
For bathtubs with	max. height of the tub wall 45,5 - 55,5 cm
Weight	6,5 kg
Max. load	130 kg

Bath boards

The bath boards are made of injection moulded and recyclable white plastic. They enable the user to sit comfortably on the bathtub. A smooth surface makes cleaning easier.

The bath boards are easy to assemble. The easily adjustable, robust safety plugs secures the board on the inside of the tub. The handle is easy to grip and increases safety



Bath board item nr. 302030



Bath board item nr. 302031



Bath board item nr. 302034



Replacement handle, available in red or blue

Technical data	302030	302031	302034
Outer dimensions (L x W x H)	71 x 32 x 19 cm	70 x 35 x 17 cm	76 x 35 x 18 cm
For bathtubs with inner width	from 41 to 64 cm	from 41 to 64 cm	from 41 to 64 cm
Weight	2,7 kg	2,5 kg	2,35 kg
Max. load	200 kg	150 kg	150 kg

Bathing products

Item nr.	Description	PU *	Foto	Price
302070	Shower stool, white, with grey Polyuretane seat, seat width 42 cm	3 pcs.	OX8	128,00 €
302071	Shower stool, silver, with grey Polyuretane seat, seat width 42 cm	3 pcs.	OX8	128,00 €
302072	Shower stool, white, with grey Polyuretane seat, seat width 47 cm	3 pcs.	OX8	136,00 €
302073	Shower stool, silver, with grey Polyuretane seat, seat width 47 cm	3 pcs.	OX8	136,00 €
302078	Shower stool, white, with grey Polyuretane seat, seat width 52 cm	2 pcs.	OX8	179,00 €
302079	Shower stool, silver, with grey Polyuretane seat, seat width 52 cm	2 pcs.	OX8	179,00 €
30207X	Shower stool, white, with grey Polyuretane seat, seat width 57 cm	2 pcs.	OX8	224,00 €

302090	Self-standing support rail, height adjustable	4 pcs.	OX20	75,00 €
--------	---	--------	------	---------

302012	Bathtub seat - grey with PU seat	2 pcs.	OX10B	134,00 €
--------	----------------------------------	--------	-------	----------

302022	Swivel bather - grey with PU seat	1 pc.	OX11A	241,00 €
--------	-----------------------------------	-------	-------	----------

302010	Foldable shower chair - white	1 pc.	OX1	176,00 €
--------	-------------------------------	-------	-----	----------

302011	Foldable commode chair - white, with lid and bucket	1 pc.	OX2	202,00 €
--------	---	-------	-----	----------

302040	Wall mounted shower chair	1 pc.	OX5	170,00 €
--------	---------------------------	-------	-----	----------

302064	Round shower stool, aluminium, silver with white ø33 cm seat	2 pcs.	OX3A	44,50 €
--------	--	--------	------	---------

302063	Round shower stool, aluminium, silver with white ø33 cm seat (flat pack)	1 pc.	OX3A	43,50 €
--------	--	-------	------	---------

302066	Shower stool, aluminium, silver with white ø33 cm swivel seat	1 pc.	OX3B	60,00 €
--------	---	-------	------	---------

302067	Triangular shower stool, silver with white seat 40 x 41 cm	5 pcs.	OX4A	62,00 €
--------	--	--------	------	---------

302069	Triangular shower stool, silver with white seat 33 x 35 cm	5 pcs.	OX4B	52,00 €
--------	--	--------	------	---------

302050	Shower stool from aluminium, silver frame and white seat	5 pcs.	OX12	47,00 €
--------	--	--------	------	---------

302065	Sliding bath bench	1 pc.	OX6	234,00 €
--------	--------------------	-------	-----	----------

Item nr.	Description	PU *	Foto	Price
302030	Shower board, white, with handle, max 200 kg, L = 70 cm	5 pcs.	OX7A	53,00 €
302031	Shower board, white with handle, max 150 kg, L = 70 cm	5 pcs.	OX7B	44,50 €
302034	Shower board, white with handle, max. 150 kg, L = 76 cm	5 pcs.	OX7C	51,00 €

Spare parts and accessories for bathing products

Item nr.	Description	PU *	Foto	Price
302085	Legs for shower stool item no. 302070-73, 4 pcs. incl. tips	1 pc.		23,50 €
302086	Legs for shower stool item no. 302078-79, 4 pcs, incl. tips	1 pc.		27,50 €
295122	Clamp for ø25 mm tube with ø6 x 15 mm bolt, for back 302075/76	1 pc.	D3	1,00 €
295126	Clamp for ø25 mm tube with ø6 x 32 mm bolt, for legs for 302070-79	1 pc.	D3	1,00 €
302033	Feets for bathboard 302030 (4 pcs)	1 pc.		11,50 €
302035	Blue handle for white shower board 302031 or 302034	1 pc.	OX7D	16,00 €
302032	Red handle for white shower board 302030	1 pc.	OX7D	8,50 €
302140	Red supporthandle for 302065	1 pc.	OX7D	7,50 €
226126	Tips for shower stool item no. 302070-79, ø22 mm	1 pc.	D12C	1,25 €
302081	PU seat for 42 cm shower stool	1 pc.		44,50 €
302082	PU seat for 47 cm shower stool	1 pc.		51,00 €
302083	PU seat for 52 cm shower stool	1 pc.		55,00 €
302062	PU seat for 302067. grey	1 pc.	OX1	23,50 €
302061	PU seat for 302069. grey	1 pc.	OX1	19,00 €
302076	Back for shower stool, silver with grey polyurethane upholstery	1 pc.	OX9A	51,00 €
302075	Back for shower stool, white with grey polyurethane upholstery	1 pc.	OX9A	51,00 €

* PU = Packaging unit

KAKADU KAKADU



Leaflet OY

"Kakadu" commode and shower chairs
standard and with tilt function

"Kakadu" commode and shower chair made of aluminium



"Kakadu" commode and shower chair standard equipped with 4 pieces of 5" castors



"Kakadu" commode and shower chair equipped with 24" wheels with quick release (optional)

The "Kakadu" commode and shower chair has a frame made of white anodized aluminium and comes as standard with 4 pieces of 5" castors with parking brakes. The seat, backrest and armrests are made of soft black PU. The foot rests are easily adjustable in height and are removable. All "Kakadu" chairs are supplied as standard with toilet bucket with carrying handle, lid and black PU seat cover.

The commode and shower chair can be equipped with 24" rear wheels with parking brakes. In the 24" wheel kit are included 2 brakes with clamps and brackets for fitting of the wheels on the frame. Pre-drilled holes makes the mounting of the wheels very easy. Antitip is optional.

Accessories for "Kakadu" commode and shower chair

For the commode and shower chair series "Kakadu" different accessories are available. See price list for the full range of accessories.



Amputation support



Security bar



Anti-tip - ATTENTION: usable only with mounted 24" wheels

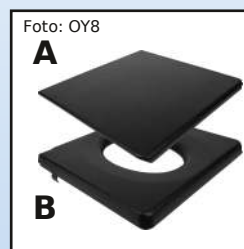

Closed seat (A) and seat cover with round hole (B)



Velcro backrest



The safety belt without metal parts can also be used as an additional support belt



Side support for showerchair. Available in 2 dimensions



Foam cushion made of soft PU foam, with waterproof Decutex cover



Foam cushion made of soft PU foam, open at the front, with waterproof Decutex cover



Splash guard front for standard seats (with open front)

"Kakadu" Tilt commode and shower chair made of aluminium with tilt



"Kakadu" commode and shower chair with tilt function



"Kakadu" commode and shower chair tilted

The commode and shower chair with tilt can be angled from -5° to $+25^{\circ}$. Head support with cut for ears, can be adjusted in height, depth and in the angle. The black padding is as the head support covered with soft PU. All "Kakadu" chairs are supplied as standard with toilet bucket with carrying handle, lid and black PU seat cover.

As standard the "Kakadu" Tilt is fitted with 5" wheels, but it can be equipped with 24" rear wheels with parking brakes. In the 24" wheel kit are included 2 brakes with clamps and brackets for fitting of the wheels on the frame. Pre-drilled holes makes the mounting of the wheels very easy. Anti-tip is optional.

Technical data	Small 302015	Standard 302018	Large 302019	XL 302020	Tilt 302024	Tilt L 302025	Difference with 24"
Seat width	38 cm	45 cm	50 cm	55 cm	45 cm	50 cm	---
Seat depth	38 cm	43 cm	43 cm	43 cm	43 cm	43 cm	---
Seat height adjust.	50 - 55 cm	50 - 55 cm	50 - 55 cm	50 - 55 cm	55 - 60 cm	55 - 60 cm	---
Seat opening	17 x 33 cm	21,3 x 40,5	21,3 x 40,5	21,3 x 40,5	21,3 x 40,5	21,3 x 40,5	---
Pass over height **	42,5 - 47,5 cm	43 - 48 cm	42 - 47 cm	40 - 45 cm	40 - 45 cm	40 - 45 cm	---
Pass over width	32 cm	40 cm	45 cm	50 cm	35 cm	40 cm	---
Seat/Back angle	$90^{\circ} / 12^{\circ}$						---
Distance between armrests	39,5 cm	46,5 cm	51,5 cm	56,6 cm	46,5 cm	51,5 cm	---
Backrest height	46 cm						---
Total width *	49 cm	56 cm	61 cm	66 cm	56 cm	61 cm	+ 9,5 cm*
Total depth	85 cm	93 cm	93 cm	93 cm	110-120 cm	110-120 cm	+ 19 cm
Total height adjust.	96-101 cm	96-101 cm	96-101 cm	96-101 cm	97-141 cm	97-141 cm	---
Max. load	130 Kg	150 Kg	150 Kg	200 kg	150 Kg	150 Kg	---
Weight	11,00 Kg	12,90 Kg	13,50 Kg	14,10 kg	15,10 kg	15,70 kg	+ 4,20 kg
Tilt angle	---	---	---	---	-5° bis $+25^{\circ}$	-5° bis $+25^{\circ}$	---

* Total width: Difference for Kakadu Tilt (302024 or 302025) with 24" wheels mounted: + 14 cm

** +5 cm with the new accessory 30212M

"Commode Liner" hygiene bags

The new patented **Commode Liner Disc** is a unique, portable, flexible shower chair accessory that is easy and hygienic to use.

The Liner Disc is used in conjunction with the **Commode Liner bags** (sold separately) and can be easily placed on and removed from the seat to prevent contamination of the seat and bucket. The hygiene bags are available with plastic seat pad (picture OY90) or without (picture OY91).

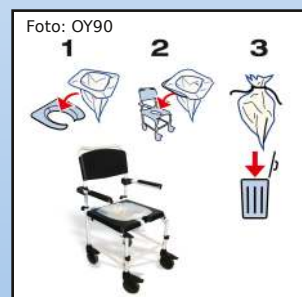

Commode Liner Disc



Commode Liner

Commode and shower chair "Kakadu"

Item nr.	Description	Foto	Price
302015	Commode and shower chair with 4 lockable 5" wheels, seat width 38 cm	OY1	468,00 €
302018	Commode and shower chair with 4 lockable 5" wheels, seat width 45 cm	OY1	468,00 €
302019	Commode and shower chair with 4 lockable 5" wheels, seat width 50 cm	OY1	547,00 €
302020	Commode and shower chair with 4 lockable 5" wheels, seat width 55 cm	OY1	623,00 €

302024	Commode and shower chair with tilt and 4 lockable 5" wheels and head rest, SW: 45	OY3	786,00 €
302025	Commode and shower chair with tilt and 4 lockable 5" wheels and head rest, SW: 50 cm	OY3	850,00 €

Item nr.	Description	Foto	Price
302017	24" Plastic wheels with quickrelease for commode and shower chair 302015,18, 19 and 20 incl. adapter, pair	OY2	245,00 €
302023	24" Plastic wheels with quickrelease for commode and shower chair 302024 and 25 incl. adapter, pairs	OY2	277,00 €

Spare parts for the commode and shower chair "Kakadu" (for prices see next page)

Foto OY4a

	A	B	C	D
302015	30312E	30212C	30212G	30212F
302018	302111	302107	302131	302132
302019	302112	302106	302131	302132
302020	302118	302120	302131	302132
302024	302111	302107	302131	302132
302025	302112	302106	302131	302132

Mobilex	Mobilex A/S	Material			
DK-8660	Skanderborg				
DESIGN	NAME	DATE	SIGNATURE		
APPROVED				APPLY TO TYPE	DWG NO: POS
SCALE			SHEET	EDITION:	
DESIGNATION				DWG NO:	12.2020
					KAKADU Showerchair

Spare parts

Item nr.	Description	Foto	Price
30212M	5" wheel incl. 145 mm extended alutube for shower-commode Kakadu, all types	OY4A	51,00 €
302130	5" wheel incl. alu tube for shower chair 302015/18/19/24/25, from year 2016	OY4A	41,50 €
302121	5" wheel incl. alutube for shower-commode 302018/19/20/24, until year 2015	OY4A	41,50 €
30212J	5" wheel reinforced incl. alutube for shower-commode 302020	OY4A	38,50 €
302124	Adapters for mounting 24" wheels on 302018.19.20, pair	OY4A	26,50 €
30212B	Adapters for mounting 24" wheels on 302024-25, pair	OY4A	27,50 €
302116	Armrest bracket, left, for all models	OY4A	15,00 €
302117	Armrest bracket, right, for all models	OY4A	15,00 €
302145	Bracket for fitting of head support 302141	OY4A	39,50 €
302151	Brake for 302015/18/19/20/24/25 incl. bracket, left	OY4A	25,50 €
302152	Brake for 302015/18/19/20/24/25 incl. bracket, right	OY4A	25,50 €
30212T	Bucket holder for Kakadu 302015, pair	OY4A	15,00 €
30212L	Bucket holder for Kakadu 302018-302025, pair	OY4A	15,00 €
302101	Bucket with lid for shower and commode chair Kakadu, all types	OY4A	18,00 €
D2101	Complete head support for Kakadu 302024 and 302025 (ALSO ITEM 302150)	DZ36	149,00 €
302113	Fingerscrew for fitting of backrest on shower-commodechair Kakadu	OY4A	3,25 €
302144	Fingerscrew for fitting of headrest 302141	OY4A	1,25 €
302162	Gas spring, 150N for Kakadu Tilt 302024	OY4A	138,00 €
302108	Gas spring, 170N for Kakadu Tilt 302025	OY4A	138,00 €
302163	Gas spring, 100N for Kakadu Tilt	OY4A	134,00 €
302141	Headrest from PU	OY4A	68,00 €
302143	Headrest holding set for headrest 302141 incl. screws	OY4A	25,50 €
30214A	Headrest stand for mounting on 302015+18+19+20	OY4A	29,50 €
302131	Leg support complete for shower-commode chair 302018/19/20/24/25, left	OY4A	62,00 €
302132	Leg support complete for shower-commode chair 302018/19/20/24/25, right	OY4A	62,00 €
30212G	Leg support complete for shower-commodechair 302015, left	OY4A	55,00 €
30212F	Leg support complete for shower-commodechair 302015, right	OY4A	55,00 €
30212D	Lid 17 x 33 cm, for PU seat for 302015	OY4A	21,50 €
302103	Lid 21,3 x 40,5 cm, for PU seat, reinforced for 302018/19/20/24/25	OY4A	27,50 €
302137	Locking bracket for foot rest for Kakadu	OY4A	7,50 €
302114	Plast clip for seat for 302018/19/24	OY4A	2,25 €
302136	Plastic bushing for foot rest for Kakadu	OY4A	3,25 €
30212N	Plastic part with locking system for legsupport Kakadu for all types	OY4A	21,50 €
302115	PU armrest pads 240 mm incl. screws, for Kakadu, all types	OY4A	13,00 €
30212E	PU back for shower and commode chair width 38 cm / 302015	OY4A	60,00 €
302111	PU back for shower-commodechair width 45 cm / 302018 and 302024	OY4A	55,00 €
302112	PU back for shower-commodechair width 50 cm / 302019 and 302025	OY4A	77,00 €
302118	PU back for shower-commodechair width 55 cm / 302020	OY4A	83,00 €
30212C	PU seat 38 cm for 302015 incl. bucket holder, without lid	OY4A	111,00 €
302107	PU seat 45 cm for 302018/24 incl. bucket holder, without lid	OY20	126,00 €
302106	PU seat 50 cm for 302019/25, without bucket holder, without lid	OY20	126,00 €
302120	PU seat 55 cm, for 302020, without bucket holder, without lid	OY4A	147,00 €
302119	Pushrim for 24" wheel of 302017/23 set	OY4A	17,00 €
302148	Release handle incl. 2 cables for shower-commode chair 302024/25	OY4A	26,50 €
302142	Rod for headrest 302141	OY4A	18,00 €
302153	Set with 4 stainless screws for 5" and 24" wheels for Kakadu shower chair	OY4A	4,25 €

Info for the 5" wheels

Foto: OY17

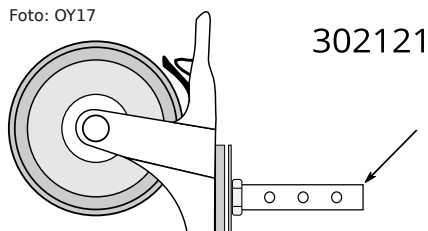

The 5" wheel up to year 2015 does not have any plastic head

Foto: OY18

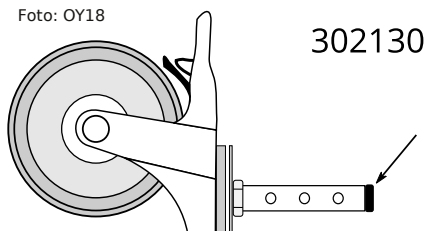

The 5" wheel from year 2016 has a black plastic head at the top of the tube

Foto: OY19

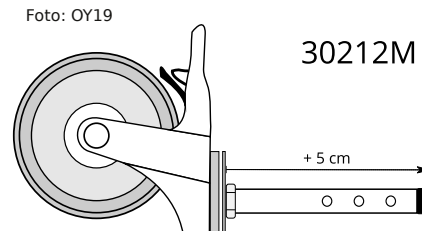

The extended 5" wheel to increase the pass over height
ATTENTION: Not usable with mounted 24" wheels

Mobilex A/S - Price list

All prices are per pcs. and in EUR.

07.2022

Leaflet OY

Accessories

Item nr.	Description	Foto	Price
302128	Amputation support, left, for bathchair 302018/19/24/25	OY5	104,00 €
302129	Amputation support, right, for bathchair 302018/19/24/25	OY5	104,00 €
302195	350 mm armrest with pipe 25.4 x 470 mm for commode and shower chair Kakadu		40,50 €
302126	Safety bar for bath chair 302019 and 302025 (55 cm for SW 50 cm)	OY6	34,00 €
302127	Safety bar for bath chair 302018/24 (50 cm for SW 45 cm)	OY6	34,00 €
302149	Safety bar for bath chair 302020 (59 cm for SW 55 cm)	OY6	34,00 €
302125	Anti-tip for "Kakadu" showerchair, all models from 2015 onwards (1 pc.)	OY7	17,00 €
302109	PU seat with round hole for Kakadu width seat width 45 cm	OY8B	119,00 €
302154	PU seat with round hole for Kakadu width seat width 50 cm	OY8B	132,00 €
302156	PU seat with round hole for Kakadu width seat width 55 cm	OY8B	155,00 €
302110	Seatplate lid for 302018/302024, SW 45 cm	OY8A	63,00 €
302155	Seatplate lid for 302019/302025, SW 50 cm	OY8A	77,00 €
302157	Seatplate lid for 302020, SW 55 cm	OY8A	89,00 €
30212Z	Closed footplate 165 x 320 mm for Kakadu commode and shower chair		62,00 €
302122	Safety belt (+ strap for backrest) for Kakadu, all versions	OY10	21,50 €
302164	Adjustable back for Kakadu with seat width 45 cm	OY9	51,00 €
302165	Adjustable back for Kakadu with seat width 50 cm	OY9	53,00 €
302166	Adjustable back for Kakadu with seat width 55 cm	OY9	55,00 €
30212R	Side support for shower chair - 10 x 14 cm - right side	OY11	55,00 €
30212P	Side support for shower chair - 10 x 14 cm - left side	OY11	55,00 €
30212S	Side support for shower chair - 14 x 20 cm - right side	OY11	60,00 €
30212Q	Side support for shower chair - 14 x 20 cm - left side	OY11	60,00 €
30211U	Seat upholstery for seat with round hole (closed in front)	OY12	83,00 €
30210U	Seat upholstery with hygiene cut (with open front)	OY13	83,00 €
30214U	Splash guard front for Kakadu with standard seat (with open front)	OY14	21,50 €

Commode Liner Disc (Hygiene Tüten für Toiletteneimer)

Item nr.	Description	Foto	Price
302170	Commode Liner Disc toilet seat pad	OY90	32,00 €
302171	Commode Liner toilet bucket bags for Disc (box with 20 pcs.)	OY90	47,00 €
302172	Commode Liner toilet bucket bags for Disk (roll with 20 pcs.)	OY90	34,00 €
302173	Commode Liner toilet bucket bags (roll with 20 pcs.)	OY91	34,00 €

OTHER AIDS

OTHER AIDS



Leaflet Q

Pedal trainer, crutches and canes,
overbed table, reachers etc.

Foldable pedal trainer

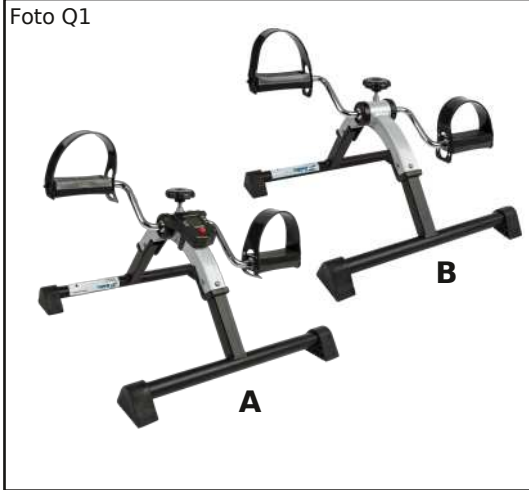

Pedal trainer with (A) or without LCD (B)

Simple but robust arm and pedal trainer with manually adjustable pedalling resistance. The pedal trainer has a massive frame and plastic pedals with adjustable strap. It is available with or without LCD.

Dimensions: 44 × 39 × 26 cm (L × B × H)

Forearm crutch



Forearm crutch

Height-adjustable forearm crutch, silver with black handle and **soft hand rest** with reflector.

*Total height 94 to 121 cm
Handle height 72 to 99 cm
Weight 0.5 kg
Load capacity 150 kg*

Rollable bed table



Rollable bed table

Bed table with multiple adjustment options. The height of the worktop can be adjusted between 72 and 110 cm and can be tilted steplessly to either side.

Dimensions of the worktop: 55 × 41 cm (L × W)

Walking stick



Walking stick one-piece (left) or foldable (right)

Height-adjustable walking stick made of black aluminium, with black handle.

*Height adjustable:
From 73.6 to 96.5 cm (one-piece: 315015)
From 85.0 to 95.0 cm (foldable: 315016)
Load capacity 100 kg (both models)*

Ice pick



Ice pick

Ice pick for attachment to canes or walking sticks. When not in use it can be folded up.

Cane holder



Cane holder

Is clamped to the cane, so that the cane can be placed for example to the edge of a table.

Reacher



Reacher 87 cm, 74 cm (upper image) or 59 cm long



Reacher



Hook on one reacher's end



Magnet on one reacher's end

Reacher with an aluminium structure and an ergonomic handle. In one end the reacher is equipped with a hook and a magnet and supports people with disabilities to reach or pick up small objects.

Available in 3 measures: 87 cm, 74 cm or 59 cm

Mobilex A/S - Price list

All prices are per pcs. and in EUR.

07.2022

Leaflet Q

Other aids

Item nr.	Description	PU *	Foto	Price
272002	Pedal trainer, silver, foldable	5	Q1B	40,50 €
272003	Pedal trainer, silver, foldable, with digital screen	5	Q1A	58,00 €

Item nr.	Description	PU *	Foto	Price
272010	Overbed table, angle adjustable, with frame, height adjustment from 72-115 cm	4	Q2	85,00 €

Item nr.	Description	PU *	Foto	Price
315021	Forearm crutch, silver with black plastic cuff, soft grey dual layer handle, heightadj. from 94 - 121 cm	20	Q3A	15,00 €

Item nr.	Description	PU *	Foto	Price
315015	Walking cane, black, height adjustable from 76 - 98 cm	1	Q3B	15,00 €
315016	Walking cane, black, foldable model and height adjustable from 85 - 95 cm	1	Q3B	17,00 €

Item nr.	Description	PU *	Foto	Price
315101	Universal ice pick for crutches and walking cane	10	Q4	5,75 €
315102	Cane holder	10	Q5	4,75 €

Item nr.	Description	PU *	Foto	Price
315040	Reacher 59 cm	10	Q6	14,00 €
315041	Reacher 74 cm	10	Q6	15,00 €
315042	Reacher 87 cm	10	Q6	16,00 €

* PU: pieces per packing unit

**ATTENTION! Normally we deliver complete packaging units
Please try to fit your orders to the indicated packing units.**

ROLLATORS

ROLLATORS



Leaflet RB - RT

Indoor- and outdoor-rollators,
arthritis rollators, walking frames
and shopping trolleys

The **Impala** rollator has a metallic blue-coloured aluminium frame. The folding system reduces in folded state space requirements to a minimum. The rollator is equipped with a cane holder, padded seat and backrest and a handy bag under the seat. Easy to open and close the rollator with its large 200 mm wheels is suitable for use both outdoors and indoors. The push handles can be easily adjusted in height by the user and provides comfortable and safe walking. The rollator is equipped with two lockable brakes on the rear wheels.

Mobilex rollator Impala	Standard Item nr. 312060	High Item nr. 312061	Wide Item nr. 312062
<i>Height of the push handles (adjustable)</i>	79 - 93 cm	90 - 105 cm	79 - 93 cm
<i>Seat height</i>	53 cm	63 cm	53 cm
<i>Total width opened / folded</i>	60 / 27 cm	63 / 35 cm	66 / 27 cm
<i>Inner width between push handles</i>	48 cm	49 cm	53 cm
<i>Length (depth)</i>	70 cm	75 cm	70 cm
<i>Weight</i>	7,4 kg	7,9 kg	7,5 kg
<i>Max. load (rollator / bag)</i>	150 kg / 5 kg	150 kg / 5 kg	150 kg / 5 kg
<i>Brakes</i>	2 lockable with parking function		
<i>Wheel sizes</i>	Front and back 200 x 35 mm		



The Impala rollator



The folded rollator



Basket to insert in the bag under the seat (accessory)



Basket to put outside of the bag on the frame (accessory)

Impala Rollator

Item nr.	Description	Foto	Price
312060	Impala Rollator, blue metallic, with bag, back belt and cane holder	RI1A	166,00 €
312061	Impala Rollator, high model, blue metallic, with bag, back belt and cane holder	RI1A	185,00 €
312062	Impala rollator, blue metallic, wide model, with bag, back belt and cane holder	RI1A	185,00 €

Spare parts and accessories

Item nr.	Description	Price
201073	7" rubber wheels, 185 x 30 mm, flat profile, incl. distance bushing, 45 mm width	15,00 €
312068	8" wheel for Impala rollator	13,00 €
312063	Bag for Impala, 340 x 190 x 160 mm (standard bag does not fit basket, use 312073)	13,00 €
312074	Basket for Impala rollator, 440 x 282 x 209 mm, for use outside on rollator frame	13,00 €
312073	Basket for Impala rollator, 400 x 250 x 140 mm, with bag that fits in the basket	13,00 €
312066	Brake handle, left, with cable and push handle for Impala rollator 312060 and 312062	21,50 €
31206D	Brake handle, left, with cable and push handle for Impala rollator 312061	21,50 €
312067	Brake handle, right, with cable and push handle for Impala rollator 312060 and 312062	21,50 €
31206E	Brake handle, right, with cable and push handle for Impala rollator 312061	21,50 €
312069	Brakeshoe for Impala, pairs	4,50 €
312065	Crutch holder for Impala consisting of clamp and cup	9,50 €
312078	Front wheel axle for Impala	2,75 €
31206C	Frontfork for Impala rollator	23,50 €
31206J	Plastic bracket for back tube for Impala rollator, set of 2 pieces with bolts	11,00 €
31206F	Plastic protection ring for Impala rollator frame tube	1,00 €
312079	Rear wheel axle	2,75 €
312064	Seat for Impala rollator	17,00 €
312027	Starhandle incl. bolt and nut for handle adjustment	3,25 €

The **Kudu** lightweight rollator has a black or silver coloured aluminium frame that can be folded sideways which in folded state reduces the required space to a minimum. The rollator is equipped with a back strap and comes also with a handy removable bag made of tear-resistant nylon. The bag has carrying handles and can also be used as a shopping bag. Easy to expand and collapse the rollator with its large 200 mm wheels is suitable for use both outdoors as indoors. The comfortable seat is made of tear-resistant nylon. The push handles can be adjusted in height and allow a comfortable and secure progress. The rollator comes with two lockable brakes on the rear wheels, with tip-assist, a crutch holder and a bike bell.

Mobilex rollator Kudu	Standard Item nr. 312075	Medium Item nr. 312076	Small Item nr. 312077
<i>Height of the push handles (adjustable)</i>	80 – 98,5 cm	79 – 88 cm	69 - 80 cm
<i>Seat size (H x W x D)</i>	65 x 42 x 20,5 cm	57 x 42 x 20,5 cm	50 x 42 x 20,5 cm
<i>Size of the folded rollator (H x W x D)</i>	82 x 29 x 67 cm	79 x 27 x 68 cm	67 x 27 x 72 cm
<i>Total width</i>	61 cm	61 cm	61 cm
<i>Inner width between push handles</i>	45,5 cm	45,5 cm	45,5 cm
<i>Length (depth) opened</i>	67 cm	68 cm	70 cm
<i>Weight</i>	8,0 kg	7,9 kg	7,7 kg
<i>Max. load (rollator / bag)</i>	150 kg / 5 kg	150 kg / 5 kg	150 kg / 5 kg
<i>Brakes</i>	2 lockable with parking function		
<i>Wheel sizes</i>	Front and back 200 x 35 mm		



Mobilex Kudu rollator



The folded Kudu rollator

Standard equipment



Bike bell



Tray

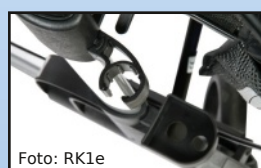

Cane-holder



Tip-assist

Kudu Rollator

Item nr.	Description	Foto	Price
312075	Kudu Rollator, silver, SH: 65 cm., incl. tray, back belt and cane holder	RK1A	305,00 €
312076	Kudu Rollator, silver, SH: 57 cm, incl. back belt, tray and cane holder	RK1A	305,00 €
312077	Kudu Rollator, silver, SH: 50 cm, incl. back belt, tray and cane holder	RK1A	305,00 €

Spare parts and accessories

Item nr.	Description	Price
312138	Adapter for fitting of crutch holder on 312076 + 312077	1,00 €
312123	Back belt for Kudu rollator	13,50 €
312122	Bag for Kudu rollator	27,00 €
312124	Basket rain cover for Kudu rollator	9,00 €
312134	Bell for Kudu rollator	4,25 €
312131	Brake for Kudu rollator	6,50 €
312126	Brake handles complete, left side, for Kudu rollator	26,00 €
312125	Brake handles complete, right side, for Kudu rollator	26,00 €
312127	Cable for brake for Kudu rollator	4,50 €
312133	Crutch holder for Kudu rollator, holder + cup	5,50 €
312137	End cap for Kudu wheels	0,50 €
312128	Fingerscrew for Kudu rollator	5,25 €
312144	Frontfork for Kudu rollator	18,50 €
312141	Locking device for Kudu rollator SH 48 cm	18,00 €
312142	Locking device for Kudu rollator SH 55 cm	18,00 €
312143	Locking device for Kudu rollator SH 65 cm	18,00 €
312139	Plastic bracket that holds Kudu together when folded	5,25 €
312145	Plastic bushing with thread for handle on Kudu rollator, right side	2,50 €
312146	Plastic bushing with tread for handle on Kudu rollator, left side	2,50 €
312130	Seat for Kudu rollator	12,50 €
312121	Tray for Kudu rollator	10,50 €
312132	Wheel, 200 mm for Kudu rollator	19,50 €

The Mobilex **Panther** lightweight rollator has a blue aluminium frame. The rollator folds easily sideways and takes up little space when folded, making it easy to transport. The seat is made of durable, long-lasting material that provides comfort and stability for the user. At the front there is a removable bag with two handles that can also be used for shopping. The large wheels make the rollator well suited for both indoor and outdoor use, it is stable and effectively absorbs shocks. The push handles can be adjusted in height very easily and without tools. The rollator is equipped with 2 lockable brakes that brake on the rear wheels. A tilt pedal is integrated on the rear frame to make it easier to negotiate smaller obstacles. The rollator is tested and approved for a user weight of up to 150 kg and is available in two sizes, Standard and Small (see table below).

Foto: RP1a



Mobilex rollator Panther	Standard 318001	Small 318002
<i>Height of the push handles (adjustable)</i>	78 - 101 cm	71 - 93 cm
<i>Recommended user heights</i>	150 - 195 cm	140 - 187 cm
<i>Seat height</i>	62 cm	55 cm
<i>Total width opened / folded</i>	62 / 22 cm	62 / 22 cm
<i>Inner width between push handles</i>	43 cm	43 cm
<i>Length (depth)</i>	75,5 cm	75,5 cm
<i>Weight (+ bag 380 g)</i>	6,73 kg	6,25 kg
<i>Max. load (rollator / bag)</i>	150 kg / 5 kg	150 kg / 5 kg
<i>Brakes</i>	2 lockable with parking function	2 lockable with parking function
<i>Wheel sizes</i>	Front and back 200 x 35 mm	Front and back 200 x 35 mm

Panther Rollator

Item nr.	Description	Foto	Price
318001	Panther rollator, blue, seat height 62 cm, incl. backbelt and cane holder	RP1A	245,00 €
318002	Panther rollator, blue, seat height 55 cm, incl. backbelt and cane holder	RP1A	245,00 €

Spare parts and accessories

Item nr.	Description	Price
318013	Backbelt for Panther rollator	16,00 €
318012	Bag for Panther rollator	16,00 €
318024	Black end cap for hub on rear wheels for Panther rollator	2,75 €
318023	Brake cabel incl. spring and tightner for Panther rollator	6,50 €
318027	Brake for Panther rollator	6,50 €
318022	Brake handles complete, left side, for Panther rollator	38,50 €
318021	Brake handles complete, right side, for Panther rollator	38,50 €
318034	Brake pad for Panther rollator (set for 2 wheels)	19,00 €
318032	Crutch holder (set) for Panther rollator	11,50 €
318016	Ergonomical handle with reflex, left, for Panther rollator	5,25 €
318015	Ergonomical handle with reflex, right, for Panther rollator	5,25 €
318031	Front fork for Panther rollator	9,00 €
318028	Front wheel 200 mm (8"), silver, for Panther rollator	20,00 €
318025	Lock that secures Panther and Elephant Air rollator when folded	4,75 €
318026	Locking device for Panther rollator, seat height 62 cm	25,50 €
318036	Plastic part for front tubes for Panther rollator (old version)	2,25 €
318035	Plastic part for mounting of brake handles for Panther rollator	2,75 €
318029	Rear wheel 200 mm (8"), silver, for Panther rollator	20,00 €
318014	Seat for Panther rollator	12,00 €
318033	Tubes for bag for Panther rollator (complete set with 2 plastic tubes)	6,50 €

Attention!

The Panther rollator is currently no longer available and will be replaced by an improved version, which is expected to be available from autumn '24.

The **Puma Air** rollator is a newly developed, high-quality outdoor rollator. It has a matte black aluminium frame. The large wheels with 12" (295 mm) tyres guarantee great stability even on difficult surfaces. The rollator can be folded very easily by pulling the strap on the seat upwards. The push handles are easily adjustable in height without the use of any tools.

The Puma Air rollator comes standard with a back belt, a cup holder, a crutch holder and a modern, closed bag. Thanks to its large tyres, it is particularly suitable for outdoor use, but also for indoor use, as it is only 65 cm wide.

The rollator weighs 9.78 kg and is easy to transport. It is tested and approved for a user weight of **up to 150 kg**.



Foto: RPa1a



Foto: RPa1b



Foto: RPa1c

Puma Air Rollator	312501
<i>Height of the push handles (adjustable)</i>	82 – 99 cm
<i>Recommended user heights</i>	160 - 200 cm
<i>Seat height</i>	59 cm
<i>Total width opened / folded</i>	65 cm / 26 cm
<i>Inner width between push handles</i>	47,6 cm
<i>Length (depth)</i>	76,4 cm
<i>Weight</i>	9,78 kg
<i>Max. load (rollator / bag)</i>	150 kg / 5 kg
<i>Brakes</i>	2 lockable with parking function
<i>Wheel sizes</i>	Front and back: 295 mm (12") x 45 mm

Puma Air Rollator

Item nr.	Description	Foto	Price
312501	Puma Air Rollator, matte black, seat height 62 cm, incl. backbelt, cup- and cane-holder	RPA1A	338,00 €

Spare parts and accessories

Item nr.	Description	Price
312555	Axle for front wheels for Puma Air rollator	4,25 €
312556	Axle incl. distance bushing for rear wheel of the Puma Air rollator	4,25 €
312522	Back belt for Puma Air rollator	10,25 €
312520	Bag for Puma Air rollator	24,75 €
312546	Bag holder, left side, for Puma Air rollator	4,75 €
312547	Bag holder, right side, for Puma Air rollator	4,75 €
312548	Black hub protection cap, for Puma Air rollator	1,75 €
312549	Brake pad for Puma Air rollator	1,75 €
312524	Crutch holder for Puma Air rollator (set with caneholder and cup)	3,00 €
312523	Cup holder for Puma Air rollator	2,50 €
312559	Ergonomical handgrip, left, for Puma Air rollator	5,25 €
312558	Ergonomical handgrip, right, for Puma Air rollator	5,25 €
312557	Front fork including bearings for Puma Air rollator	13,00 €
312543	Front wheel including front fork for Puma Air rollator	42,25 €
312544	Handle including cable, right side, for Puma Air rollator	29,75 €
312545	Handle set including cable, left side, for Puma Air rollator	29,75 €
312541	Lifting pedal set, left and right side, for Puma Air rollator	5,00 €
312540	Locking hook for Puma Air rollator	2,50 €
312521	Seat for Puma Air rollator	12,25 €
312560	Tray for Puma Air rollator	35,00 €
312553	Tube for Puma Air rollator	10,25 €
312551	Tyre black for Puma Air rollator	17,25 €
312542	Wheel for Puma Air rollator	36,00 €

The Mobilex lightweight rollator **Leopard** has a red, blue or anthracite grey coloured aluminium frame that can be easily folded sideways which in folded state reduces the required space to a minimum. The rollator is equipped with a crutch holder, a back strap and also comes with a handy removable bag as standard. The bag has carrying handles and can be used as a shopping bag. Easy to open and fold, the rollator is suitable for use both outdoors and indoors. The comfortable seat is made of tear resistant nylon. The push handles can be easily adjusted in height without use of tools.

The rollator comes with two lockable brakes on the rear wheels and is tested and approved for a max. user load of **150 kg**.



The rollator Leopard is available in 5 colours: platin silver, anthracite grey, blue, green or red

Rollator Leopard	Standard 312301 (red) 312304 (anthracite) 312309 (blue) 312300 (green) 312303 (platin)	Standard+Softwheels 312308 (red) 312306 (anthracite) 312314 (blue) 312313 (green) 31230A (platin)	Small 312302 (anthracite) 312319 (red)	X-Small 31230K (anthrazit)	Small and Softwheels 312318 (anthracite)
<i>Height of the push handles (adjustable)</i>	74 - 102 cm	74 - 102 cm	66 - 86 cm	63 - 79 cm	66 - 86 cm
<i>Recommended user heights</i>	150 - 200 cm	150 - 200 cm	135 - 170 cm	130 - 165 cm	135 - 170 cm
<i>Seat height</i>	62 cm	62 cm	55 cm	50 cm	55 cm
<i>Total width opened / folded</i>	60 / 22,5 cm	60 / 22,5 cm	60 / 22,5 cm	60 / 22,5 cm	60 / 22,5 cm
<i>Inner width between push handles</i>	46 cm	46 cm	46 cm	46 cm	46 cm
<i>Length (depth)</i>	66 cm	66 cm	66 cm	66 cm	66 cm
<i>Weight (+ bag 380 g)</i>	7,4 kg	7,6 kg	7,1 kg	6,9 kg	7,3 kg
<i>Max. load (rollator / bag)</i>	150 kg / 5 kg	150 kg / 5 kg	150 kg / 5 kg	150 kg / 5 kg	150 kg / 5 kg
<i>Brakes</i>	2 lockable with parking function				
<i>Wheel sizes</i>	Front and back 200 x 35 mm				

Leopard Rollator seat height 62 cm

Item nr.	Description	Foto	Price
312301	Leopard rollator, red, seat height 62 cm, incl. back belt and cane holder	RL1D	317,00 €
312303	Leopard rollator, platin silver colour, seat height 62 cm, incl. back belt and cane holder	RL1E	317,00 €
312304	Leopard rollator, anthracite, seat height 62 cm, incl. back belt and cane holder	RL1A	317,00 €
312309	Leopard rollator, blue, seat height 62 cm, incl. back belt and cane holder	RL1B	317,00 €
312300	Leopard rollator, green, seat height 62 cm, incl. back belt and cane holder	RL1C	317,00 €

Leopard Rollator seat height 55 cm

Item nr.	Description	Foto	Price
31230K	Leopard rollator, anthracite grey, seat height 50 cm, incl. back belt and cane holder	RL1A	317,00 €
312319	Leopard rollator, red, seat height 55 cm, incl. backbelt and cane holder	RL1D	317,00 €
312302	Leopard rollator, anthracite grey, seat height 55 cm, incl. back belt and cane holder	RL1A	317,00 €

Leopard Rollator with soft wheels seat height 62 cm

Item nr.	Description	Foto	Price
312308	Leopard rollator with soft wheels, red, seat height 62 cm, incl. back belt and cane holder	RL1D	351,00 €
312306	Leopard rollator with soft wheels, anthracite grey, seat height 62 cm, incl. back belt and cane holder	RL1A	351,00 €
312314	Leopard Rollator with soft wheels, blue, seat height 62 cm, incl. backbelt and cane holder	RL1B	351,00 €
312313	Leopard Rollator with soft wheels, green, seat height 62 cm, incl. backbelt and cane holder	RS2A	351,00 €
31230A	Leopard rollator with soft wheels, platin silver colour, seat height 62 cm, incl. back belt and cane holder	RL1E	351,00 €

Leopard Rollator with soft wheels seat height 55 cm

Item nr.	Description	Foto	Price
312318	Leopard rollator with soft wheels, anthracite grey, seat height 55 cm, incl. backbelt and cane holder	RL1A	351,00 €

For spare parts and accessories please see leaflet RS

The lightweight **Panda Comfort** rollator has a dark blue aluminium frame. The rollator is easy to fold, takes up little space and is easy to transport. The seat is made of durable nylon. A closed shopping bag is attached to the front, which has two handles so it can be easily removed and transported separately.

The large soft wheels make the rollator very stable and easy to manoeuvre. It is suitable for both indoor and outdoor use, where the large wheels provide good shock absorption. The push handles can be adjusted in height very easily and without tools. The brakes are smooth-running and stationary. Two tilting pedals to facilitate overcoming small obstacles are attached to the frame near the rear wheels. The rollator comes standard with a locking hook when closed, a closed and removable bag, a back belt and a cane holder. A wide range of other accessories is available.

The rollator is tested and approved for a user weight of **up to 150 kg**.

Expected delivery mid/end of July 2023.



Panda Comfort rollator	312601
<i>Height of the push handles (adjustable)</i>	77,5 - 99,1 cm
<i>Recommended user heights</i>	160 - 200 cm
<i>Seat height</i>	59 cm
<i>Total width opened / folded</i>	65 cm / 26,4 cm
<i>Inner width between push handles</i>	45,5 cm
<i>Length (depth)</i>	77,5 cm
<i>Weight</i>	9,44 kg
<i>Max. load (rollator / bag)</i>	150 kg / 5 kg
<i>Brakes</i>	2 lockable with parking function
<i>Wheel sizes</i>	Front and back: 285 mm x 45 mm

Mobilex A/S - Price list

All prices are per pcs. and in EUR.

07.2022

Leaflet RPC

Panda Comfort Rollator

Item nr.	Description	Foto	Price
312601	Panda Comfort rollator, dark blue, seat height 59 cm, incl. bag belt and crutch holder	RPC1A	420,00 €

For spare parts and accessories please see leaflet RS

The Mobilex Arthritis **Tiger** and **Tiger Outdoor** rollators are based on the elegant Leopard (Tiger) and Lion (Tiger Outdoor) rollators, respectively, and therefore also have their characteristics and functions. In addition, the soft and comfortable forearm supports with their brake handles are adjustable in depth, angle and height. Apart from the model 312201, the armrests can also be turned inwards in 2 angles by 22.5 degrees each. The rollator is extremely stable and easy to manoeuvre. It has large, smooth-running wheels and has smoothrunning and lockable brakes. In the driving position it is secured against unintentional unlocking. As standard, the rollator has a transport lock and a removable shopping bag. A wide range of accessories is also available. The Rollator Tiger Standard is only approved for indoor use on level floors and for a user weight of up to **150 kg**. The Tiger Outdoor model is also approved for outdoor use with a user weight of **200 kg**.

Mobilex Rollator Tiger * with rotatable armrests	Standard Item Nr. 312201 (grey) Item Nr. 312211 (red) Item Nr. 312202 (brown) *	Outdoor Item Nr. 312205 (grey) * Item Nr. 312206 (brown) *
Height of the forearm support (adjustable)	90 cm - 115 cm	87 - 110 cm
Recommended user heights	150 - 200 cm	140 - 185 cm
Seat height	62 cm	62 cm
Total width opened / folded	62 cm / 22,5 cm	71 cm / 31 cm
Seat width / Inner width between push handles	46 cm / 36 cm	56 cm / 46 cm
Length (depth)	66 cm	77 cm
Weight (+ bag 380 g)	9,5 kg	12 kg
Max. load (rollator / bag)	150 kg / 5 kg	200 kg / 5 kg
Brakes	2 lockable with parking function	
Wheel sizes	200 x 35 mm	285/235 x 44 mm

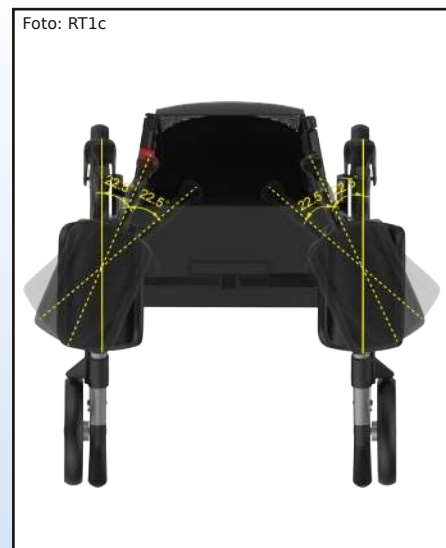

Athritis Rollator Tiger

Athritis Rollator Tiger Outdoor

Rotable armrest *

Accessories (For further accessories see leaflet RS)



Rigid padded seat

Tray

Speed reduction brake

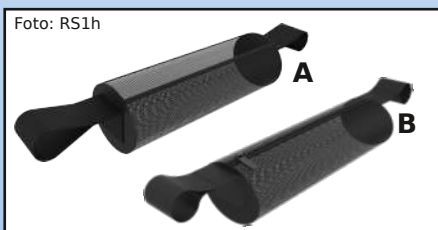

Net bag open (A), with zip (B)

Cable set for one-hand brake

Crutch holder (set)

Arthritis Rollator Tiger

Item nr.	Description	Foto	Price
312201	Arthritis rollator Tiger, anthracite grey, seat height 62 cm	RT1A	660,00 €
312211	Arthritis rollator Tiger, red, seat height 62 cm	RT1A	660,00 €

Arthritis Rollator Tiger with adjustable armrests

Item nr.	Description	Foto	Price
312202	Arthritis Rollator Tiger adjustable armpads, brown metal, seat height 62 cm	RT1C	740,00 €

Arthritis Rollator Tiger Outdoor with adjustable armrests

Item nr.	Description	Foto	Price
312205	Arthritis rollator Tiger Outdoor, anthracite grey, seat height 62 cm, inclusive backbelt	RT1E	920,00 €
312206	Arthritis rollator Tiger Outdoor, brown metal, seat height 62 cm, inclusive backbelt	RT1E	920,00 €

For spare parts and accessories please see leaflet RS

The Mobilex lightweight rollator **Buffalo HD** has an aluminium frame that can be folded sideways with in folded state reduces the required space to a minimum. Its structure is reinforced with additional elements. The rollator is equipped with a back strap, crutch holder and also comes with a handy removable bag. The bag has carrying handles and can also be used as a shopping bag. The rollator is easy to open and fold and suitable for use both outdoors and indoors. The comfortable seat is made of tear resistant nylon. The push handles can easily be adjusted in height without use of tools. The rollator comes with two lockable brakes on the rear wheels and is tested and approved for a max. user load of **200 kg**.

Mobilex rollator Buffalo HD	Standard Item nr. 312305	Small Item nr. 312307
Height of the push handles (adjustable)	74 - 102 cm	66 - 86 cm
Recommended user heights	150 - 200 cm	125 - 170 cm
Seat height	62 cm	55 cm
Total width opened / folded	68 / 22,5 cm	68 / 22,5 cm
Inner width between push handles	56 cm	56 cm
Length (depth)	66 cm	66 cm
Weight (+ bag 380 g)	7,8 kg	7,5 kg
Max. load (rollator / bag)	200 kg / 5 kg	200 kg / 5 kg
Brakes	2 lockable with parking function	
Wheel sizes	Front and back 200 x 35 mm	



Mobilex Rollator Buffalo HD



The folded rollator



Easy to operate brakes



Removable bag

Accessories (For further accessories see leaflet RS)



Rigid padded seat



Tray



Speed reduction brake



Soft wheel (silver or black)



Umbrella

Mobilex A/S - Price list

All prices are per pcs. and in EUR.

07.2022

Leaflet RB

Rollator Buffalo HD seat height 62 cm

Item nr.	Description	Foto	Price
312305	Buffalo HD rollator, anthracite grey, seat height 62 cm, incl. backbelt and cane holder	RB1A	420,00 €
312385	Buffalo rollator with soft wheels, anthracite grey, seat height 62 cm, incl. backbelt and cane holder		452,00 €

Rollator Buffalo HD seat height 55 cm

Item nr.	Description	Foto	Price
312307	Buffalo HD rollator, anthracite grey, seat height 55 cm, incl. backbelt and cane holder	RB1A	420,00 €
312387	Buffalo rollator with soft wheels, anthracite grey, seat height 55 cm, incl. backbelt and cane holder		452,00 €

For spare parts and accessories please see leaflet RS

The Mobilex rollator **Lion** is specially designed for use on off-paved or paved roads. The large soft wheels ensure a comfortable ride even over bumpy cobblestones and uneven gravel or dirt roads. The rollator can easily be folded sideways for a small space requirement and can therefore be easily transported in the car or parked at home. The rollator comes as standard with a tear resistant, comfortable textile seat, a comfortable and detachable shopping bag, a crutch holder and a back strap. The rollator is available in two metallic colours (brown or anthracite grey) and is tested and approved for a user weight of **200 kg**.

Mobilex rollator Lion	Standard	Small
	Item nr. 312372 (antracite grey) Item nr. 312374 (metallci brown)	Item nr. 312371 (antracite grey) Item nr. 312373 (metallic brown)
Height of the push handles (adjustable)	90-112 cm	77-90 cm
Recommended user heights	170 - 220 cm	165 - 175 cm
Seat height	62 cm	53 cm
Total width opened / folded	68 / 26 cm	68 / 26 cm
Inner width between push handles	56 cm	56 cm
Length (depth)	76 cm	76 cm
Weight (+ bag 380 g)	9,3 kg	9,0 kg
Max. load (rollator / bag)	200 kg / 5 kg	200 kg / 5 kg
Brakes	2 lockable with parking function	
Wheel sizes (soft wheels)	Front 285 x 44 mm - back 235 x 44 mm	



Mobilex Lion rollator



The folded rollator

Accessories (For further accessories see leaflet RS)



Rigid padded seat



Tray



One-hand brake cable set

Mobilex A/S - Price list

All prices are per pcs. and in EUR.

07.2022

Leaflet RLi

Rollator Lion seat height 62 cm

Item nr.	Description	Foto	Price
312372	Lion rollator, antrasitgrey, seat height 62 cm, incl. backbelt	RLI1A	530,00 €
312374	Lion rollator, brown metal, seat height 62 cm, incl. backbelt and cane holder	RLI1A	530,00 €

Rollator Lion seat height 53 cm

Item nr.	Description	Foto	Price
312371	Lion rollator, antracite grey, seat height 53 cm, incl. backbelt and cane holder	RLI1A	530,00 €
312373	Lion rollator, brown metal, seat height 53 cm, incl. backbelt and cane holder	RLI1A	530,00 €

For spare parts and accessories please see leaflet RS

The Mobilex lightweight rollator **Gepard** has a frame made of carbon fibre. It can be folded sideways which in folded state reduces the required space to a minimum. The rollator comes with crutch holder and is equipped with a comfortable soft seat made of tear resistant nylon. It also comes with a handy removable bag and a backstrap. The bag has carrying handles and can also be used as a shopping bag. The rollator is easy to open and fold and with its large wheels it is suitable for use both outdoors as indoors. The push handles can easily be adjusted in height. The rollator comes with two lockable brakes on the rear wheels and is tested and approved for a max. user load of **150 kg (200 kg for the HD type)**.



Rollator Gepard	Standard 312401 (black) 312403 (yellow) 312404 (purple/black)	With SOFT wheels 312406 (black) 312407 (yellow) 312408 (purple/black)	Small 312402 (black)	HD * 312405 (black)
Height of the push handles (adjustable)	74 - 102 cm	74 - 102 cm	66 - 86 cm	74 - 102 cm
Recommended user heights	150 - 200 cm	150 - 200 cm	135 - 170 cm	150 - 200 cm
Seat height	62 cm	62 cm	55 cm	62 cm
Total width opened / folded	60 / 22,5 cm	60 / 22,5 cm	60 / 22,5 cm	68 / 22,5 cm
Inner width between push handles	46 cm	46 cm	46 cm	56 cm
Length (depth)	66 cm	66 cm	66 cm	66 cm
Weight (+ bag 380 g)	5,4 kg	5,5 kg	5,1 kg	5,7 kg
Max. load (rollator / bag)	150 kg / 5 kg	150 kg / 5 kg	150 kg / 5 kg	200 kg / 5 kg
Brakes	2 lockable with parking function			
Wheel sizes	Front and back 200 x 35 mm			

Leopard Rollator seat height 62 cm

Item nr.	Description	Foto	Price
312301	Leopard rollator, red, seat height 62 cm, incl. backbelt and cane holder	RL1D	317,00 €
312303	Leopard rollator, platin silver colour, seat height 62 cm, incl. backbelt and cane holder	RL1E	317,00 €
312304	Leopard rollator, anthracite, seat height 62 cm, incl. backbelt and cane holder	RL1A	317,00 €
312309	Leopard rollator, blue, seat height 62 cm, incl. backbelt and cane holder	RL1B	317,00 €
312300	Leopard rollator, green, seat height 62 cm, incl. backbelt and cane holder	RL1C	317,00 €

Leopard Rollator seat height 55 cm

Item nr.	Description	Foto	Price
312319	Leopard rollator, red, seat height 55 cm, incl. backbelt and cane holder	RL1D	317,00 €
312302	Leopard rollator, anthracite grey, seat height 55 cm, incl. backbelt and cane holder	RL1A	317,00 €

Leopard Rollator with soft wheels seat height 62 cm

Item nr.	Description	Foto	Price
312308	Leopard rollator with soft wheels, red, seat height 62 cm, incl. backbelt and cane holder	RL1D	351,00 €
312306	Leopard rollator with soft wheels, anthracite grey, seat height 62 cm, incl. backbelt and cane holder	RL1A	351,00 €
312314	Leopard Rollator with soft wheels, blue, seat height 62 cm, incl. backbelt and cane holder	RL1B	351,00 €
312313	Leopard Rollator with soft wheels, green, seat height 62 cm, incl. backbelt and cane holder	RS2A	351,00 €

Leopard Rollator with soft wheels seat height 55 cm

Item nr.	Description	Foto	Price
312318	Leopard rollator with soft wheels, anthracite grey, seat height 55 cm, incl. backbelt and cane holder	RL1A	351,00 €

For spare parts and accessories please see leaflet RS

RolloGuard Instant Fall Protection

The innovative and fall-preventive braking systems from RolloGuard are a perfect combination with our high-quality Mobilex rollators. RolloGuard's fall protection for rollators reduces the risk of crashes or fall injuries with a rollator. The patented fall protection technology prevents accidental movements and thus enables safer mobility. RolloGuard's Instant Fall Protection is compatible with the **Buffalo**, **Gepard**, **Leopard** and **Tiger** rollator. The RolloGuard fall protection uses the "Transversor" technology, which protects against unintentional movements and makes mobility safer - for a better and safer live in motion.



Mobilex Leopard rollator with soft wheels and RolloGuard



Mobilex Leopard rollator with soft wheels and RolloGuard

Adjustable protection level

A rollator equipped with RolloGuard is marked with a sticker on the brake drum of the RolloGuard on the rear wheels. This sticker is referenced with a specific color, description and intended use. A distinction is made between the three support levels; high (red), medium (yellow) and low (green), all of which have different sensitivities, which affects the activation of the fall protection.



RolloGuard 'Transversor' technology



RolloGuard

Leopard rollator with RolloGuard Instant Fall Protection

Item nr.	Description	Foto	Price
312U33	Leopard rollator antracite with soft wheels and RolloGuard brake system, SH 62 cm	RGU1	960,00 €

RolloGuard Instant Fall Protection without rollator

Item nr.	Description	Foto	Price
D1381	RolloGuard system incl. assembly (for Leopard, Tiger and Buffalo rollator with standard wheels)		536,00 €
D1382	RolloGuard system incl. assembly (for Leopard rollator with soft wheels)		536,00 €
D1383	RolloGuard system incl. assembly (for Gepard rollator with standard wheels)		536,00 €
D1384	RolloGuard system incl. assembly (for Gepard rollator with soft wheels)		536,00 €

RollGuard spare parts

Item nr.	Description	Foto	Price
31233R	SOFT rear wheel with black colored rim for rollator with RolloGuard brake system (right side)	RGU4	268,00 €
31233S	SOFT rear wheel with black colored rim for rollator with RolloGuard brake system (left side)	RGU4	268,00 €
211085	8" x 1 1/4", black PU tyre for rollator soft wheels (e RolloGuard)		23,50 €
312395	Magnetset with 3 settings (green, yellow and red) for RolloGuard brakesystem	RGU3	10,50 €
312396	Suction cup for RolloGuard hub		16,00 €

Accessories for Leopard, Gepard, Tiger, Buffalo and Lion rollators

Foto: RS1a



Rigid padded seat

Foto: RS1b



Tray

Foto: RS1g



Umbrella with support

Foto: RS1c



Bag with zip

Foto: RS1d



Bag mit magnetic lock

Foto: RS1e



Open net bag

Foto: RS1f



Net bag with zip

Foto: RS1h



Back belts

Foto: RS1i



Crutch holder (set)

Foto: RS1j



Crutch holder for Tiger (set)

Foto: RS1k



Cable set for one-hand brake

Foto: RS1l



Speed reduction brake

Foto: RS1m



Soft wheel (silver or black)

Foto: RS1n



LED (red or white)

Foto: RS1o



Bell (red or blue)

Foto: RS1p



Holder for oxygen bottle

Spare parts for Leopard, Gepard, Tiger, Buffalo and Lion rollators

Foto: RS2A

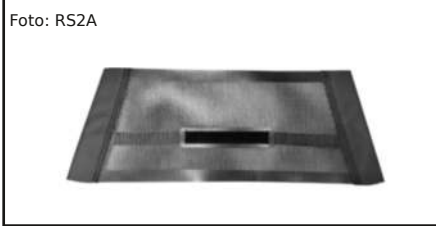

Standard seat with release strap

Foto: RS2B



Locking hook

Foto: RS2C



Tubes with red locking button

Foto: RS2D



Brake cable

Foto: RS2E



Brake pads (set)

Foto: RS2F



Handgrip with brake lever

Foto: RS2G



Handgrip with brake lever

Foto: RS2H



Underarm pad complete

Foto: DZ10



Underarm pad

Foto: RS2i



Anatomic handgrip

Foto: RS2J



Rollator bag

Foto: RS2R



Lever handle, finger screw

Foto: RS2K

Foto: RS2IL



Wheel (black or silver)

Foto: RS2M



Fork for front wheel

Foto: RS2N



Cover cap for wheel axle

Foto: RS2P



Foto: RS2Q



Foto: RS2T



Mobilex A/S - Price list

All prices are per pcs. and in EUR.

07.2022

Leaflet RS

Accessories for Leopard, Gepard, Tiger, Buffalo and Lion rollators

Item nr.	Description	Leopard		Panda	Gepard			Tiger	Tiger Out- door	Buffalo		Lion	Foto	Price
		Std.	Small	Conf.	Std.	HD	Small			Std.	Small			
312357	Back belt L=700-750 mm adjustable	X	X	X	X		X						RS1H	67,00 €
312355	Back belt L=810 mm	X	X	X	X		X						RS1H	41,50 €
312332	Back belt L=810 mm, H=200 mm	X	X	X	X		X						RS1H	60,00 €
312331	Back belt L=850 mm						X			X	X	X	RS1H	53,00 €
312342	Closable bag with magnetic lock	X	X	X	X		X	X					RS1D	58,00 €
312347	Closable bag with zipper	X	X	X	X		X	X					RS1C	52,00 €
312349	Closable bag with zipper						X			X	X		RS1C	63,00 €
31234A	Closable bag with zipper								X			X	RS1C	63,00 €
312363	Closable net bag with zipper							X					RS1F	21,50 €
312365	Closable net bag with zipper	X	X	X	X		X						RS1F	21,50 €
312367	Closable net bag with zipper						X			X	X	X	RS1F	21,50 €
312322	Crutch holder (set)	X	X	X	X	X	X			X	X	X	RS1I	17,00 €
31233D	Crutch holder (set)							X	X				RS1J	49,00 €
31236B	LED lamp for rollator, red	X	X	X	X	X	X	X	X	X	X	X	RS1N	13,00 €
31236A	LED lamp for rollator, white	X	X	X	X	X	X	X	X	X	X	X	RS1N	13,00 €
312362	Net bag open							X					RS1E	16,00 €
312364	Net bag open	X	X	X	X		X						RS1E	16,00 €
312366	Net bag open						X			X	X	X	RS1E	19,00 €
D3150	One-hand brake, assembly costs	X	X		X	X	X	X		X	X			64,00 €
312328	One-hand brake, compl. cable set *							X					RS1K	44,50 €
312329	One-hand brake, compl. cable set *	X			X	X				X			RS1K	44,50 €
31232J	One-hand brake, compl. cable set *		X				X				X		RS1K	44,50 €
31232I	Oxygen bottle holder	X	X	X	X	X	X	X		X	X	X	RS1P	60,00 €
312315	Rigid padded seat	X	X	X	X		X	X					RS1A	72,00 €
312316	Rigid padded seat						X			X	X		RS1A	69,00 €
312317	Rigid padded seat								X			X	RS1A	77,00 €
312369	Rollator bell blu	X	X	X	X	X	X	X	X	X	X	X	RS1O	13,50 €
D3151	Rollator bell red	X	X	X	X	X	X	X	X	X	X	X		45,50 €
312338	SOFT front wheel, black	X	X		X	X	X	X		X	X		RS1M	36,00 €
D1360	SOFT front wheel, black, assembly costs	X	X					X		X	X			34,00 €
31233I	SOFT front wheel, silver	X	X		X	X	X	X		X	X		RS1M	38,50 €
31233G	SOFT front wheel, silver 285 mm			X					X			X	RS1M	50,00 €
D1361	SOFT front wheel, silver, assembly costs				X	X	X							34,00 €
312337	SOFT rear wheel, black	X	X		X	X	X	X		X	X		RS1M	36,00 €
31233J	SOFT rear wheel, silver	X	X		X	X	X	X		X	X		RS1M	38,50 €
31233H	SOFT rear wheel, silver 235 mm								X			X	RS1M	41,50 €
D3151	Speed reduct. brake - Fitting costs	X	X		X	X	X	X	X	X	X	X		45,50 €
31232G	Speed reduct. brake, set for 2 SOFT wheels	X	X					X		X	X		RS1L	109,00 €
312320	Speed reduction brake, set for 2 wheels	X	X					X		X	X		RS1L	92,00 €
312323	Speed reduction brake, set for 2 wheels								X			X	RS1L	104,00 €
31232E	Speed reduction brake, set for 2 wheels				X	X	X						RS1L	109,00 €
312325	Tray	X	X	X	X		X	X					RS1B	42,50 €
312326	Tray						X			X	X		RS1B	55,00 €
31232F	Tray (only for seat hight of 62 cm)								X			X	RS1B	55,00 €
312340	Umbrella with holder	X	X	X	X	X	X			X	X	X	RS1G	113,00 €

* ATTENTION!

One-hand brakes must be re-adjusted after assembly and CANNOT BE USED IN COMBINATION WITH SOFTWHEELS!

Mobilex A/S - Price list

All prices are per pcs. and in EUR.

07.2022

Leafley RS

Spare parts for Mobilex rollators

Leopard, Buffalo, Tiger, Gepard and Lion

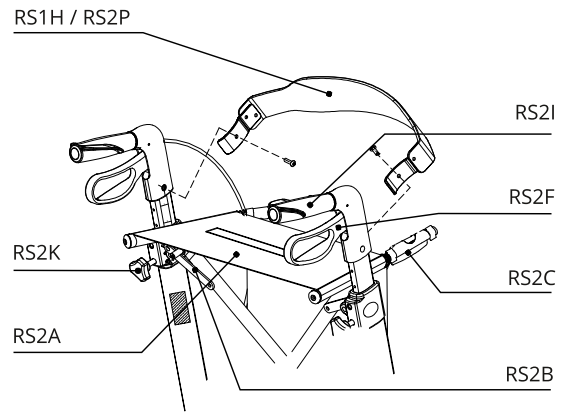
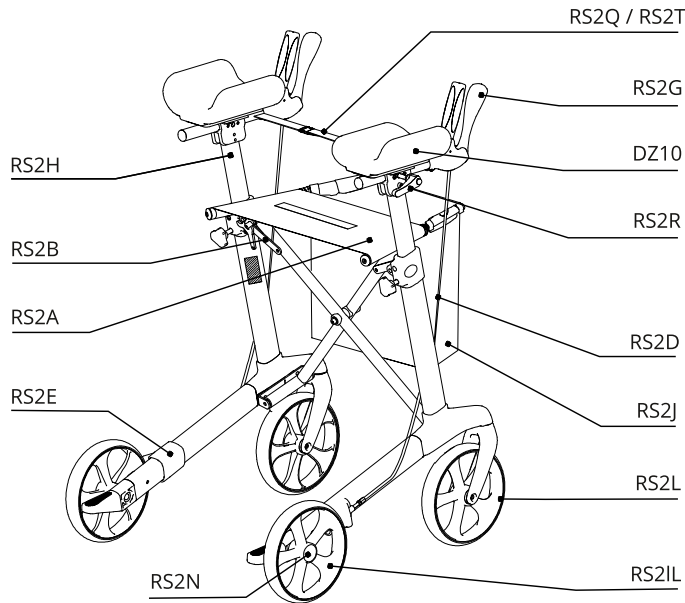

For the item nr. please see the reference in the price list

DESIGN		NAME	DATE	SIGNATURE			
APPROVED					APPLY TO TYPE	DWG NO.	POS
SCALE		SHEET		EDITION			
DESIGNATION				DWG NO.		09.2022	

Spare parts for Leopard, Gepard, Tiger, Buffalo and Lion rollators

Item nr.	Description	Leopard		Panda	Gepard			Tiger	Tiger Out- door	Buffalo		Lion	Foto	Price
		Std.	Small	Conf.	Std.	HD	Small			Std.	Small			
31233F	Anatomic handgrip, left side	X	X	X	X	X	X			X	X	X	RS2I	17,00 €
31233E	Anatomic handgrip, right side	X	X	X	X	X	X			X	X	X	RS2I	17,00 €
219901	Black cover cap for rollator wheel axle	X	X	X	X	X	X	X	X	X	X	X	RS2N	0,50 €
312327	Brake cable							X					RS2D	13,00 €
31232A	Brake cable	X	X		X	X	X			X	X		RS2D	11,50 €
31232B	Brake cable								X			X	RS2D	11,50 €
312339	Brake lever							X					RS2G	15,50 €
31232D	Brake pad (set for 2 wheels)	X	X	X	X	X	X	X	X	X	X	X	RS2E	21,50 €
312358	Finger screw for height adjustment	X	X	X	X	X	X	X	X	X	X	X	RS2K	5,25 €
31233K	Front wheel fork	X	X		X	X	X	X		X	X		RS2M	15,50 €
312334	Front wheel, black	X	X		X	X	X	X		X	X		RS2L	23,50 €
31233A	Front wheel, silver	X	X		X	X	X	X		X	X		RS2L	36,50 €
312351	Handle for height regulation of armpads							X	X				RS2R	4,75 €
31233C	Handle with brake lever left	X	X	X	X	X	X			X	X	X	RS2F	25,50 €
31233B	Handle with brake lever right	X	X	X	X	X	X			X	X	X	RS2F	25,50 €
312346	Large shopping bag				X	X	X			X	X		RS2J	52,00 €
312343	Large shopping bag for SH 55 cm												RS2J	50,00 €
312348	Large shopping bag for SH 62 cm								X			X	RS2J	48,00 €
312353	Locking hook for seat height 55 cm		X	X			X				X		RS2B	23,00 €
312352	Locking hook for seat height 62 cm	X			X	X		X		X			RS2B	23,00 €
312397	Plastic bushing for crossbar	X	X	X	X	X	X	X	X	X	X	X	RS2U	5,25 €
312335	Rear wheel, black	X	X		X	X	X	X		X	X		RS2L	23,50 €
312336	Rear wheel, silver	X	X		X	X	X	X		X	X		RS2L	39,50 €
312102	Set of forearm supports with tubes (2 pcs.)							X					RS2H	298,00 €
312361	Set tubes (incl. red locking button)	X	X	X	X	X	X	X	X	X	X	X	RS2C	31,00 €
31233Q	Stabilizing strap for the forearm supports							*	X				RS2Q	24,00 €
31233T	Stabilizing strap for the forearm supports							X					RS2T	19,90 €
31233M	Stabilizing strap / back belt								X				RS2P	64,00 €
312310	Standard seat incl. release strap	X	X	X	X		X	X					RS2A	19,00 €
312311	Standard seat incl. release strap					X				X	X		RS2A	22,50 €
312312	Standard seat incl. release strap								X			X	RS2A	23,50 €
312345	Standard shopping bag	X	X	X	X			X					RS2J	48,00 €
312333	Underarm pad for arthritis rollator							X	X				DZ10	42,50 €

* for Rollator Tiger 312205, 312306 and 312202

** for Rollator Tiger 312201 and 312211

The **Jaguar** indoor rollator has an aluminium frame and can be easily folded. Overall, the structure is very light, but offers a high level of stability coupled with extreme ease of movement. As standard, the Jaguar rollator has a bag and a removable tray. The large and smooth-running wheels are equipped with 2 lockable brakes. The rollator is only approved for **indoor use** and has been tested and approved for a user weight of up to 100 kg.



Foto: RJ1a



Foto: RJ1b



Foto: RJ1c



Foto: RJ1d



Foto: RJ1e

The **Jaguar SUPREME** (picture left) has a particularly high-quality design with wooden textured parts and with new silver-coloured wheels. The tray of the rollator also is wooden textured.

Rollator Jaguar	Various colours	SUPREME
Height of push handles (adjustable)	83,5 - 94,5 cm	90,3 - 96 cm
Size of the foldet rollator (H x W x D)	83,5 x 54,5 x 27 cm	90,3 x 56,5 x 27 cm
Width	54,5 cm	56,5 cm
Lenght (depth) opened / folded	66 cm / 27 cm	66 cm / 27 cm
Weight	6,3 kg	6,0 kg
Max. load (rollator / bag)	100 kg / 5 kg	100 kg / 5 kg
Brakes	2 lockable with parking function	
Wheel sizes	Front and back: 7" (175 x 27 mm)	



Foto: RJ1f



Foto: RJ1g



Foto: RJ1h

New colour combination red/white
Available from mid-December '23

New colour combinations green/white and blue/white
Available from march 2024

Jaguar indoor Rollator

Item nr.	Description	Foto	Price
312410	Jaguar Rollator, indoor, orange	RJ1A	222,00 €
312411	Jaguar indoor rollator, blue	RJ1B	222,00 €
312412	Jaguar indoor rollator, champagne	RJ1C	222,00 €
312413	Jaguar indoor rollator, purple	RJ1D	222,00 €
312414	Jaguar indoor rollator, red/white	RJ1F	222,00 €
312416	Jaguar indoor rollator, blue/white	RJ16	222,00 €
312417	Jaguar indoor rollator, green/white	RJ1H	222,00 €

312415	Jaguar SUPREME indoor rollator, white with wooden texture	RJ1E	258,00 €
--------	---	------	----------

Spare parts and accessories

Item nr.	Description	Price
312452	7" front wheel for Jaguar indoor rollator	15,00 €
312462	7" front wheel for Jaguar SUPREME indoor rollator	17,00 €
312453	7" rear wheel for Jaguar indoor rollator	15,00 €
312463	7" rear wheel for Jaguar SUPREME indoor rollator	17,00 €
312455	Bag for blue Jaguar indoor rollator	19,00 €
31246B	Bag for blue/white Jaguar indoor rollator	19,00 €
312459	Bag for champagne Jaguar indoor rollator	19,00 €
31246E	Bag for green/white Jaguar indoor rollator	19,00 €
312464	Bag for Jaguar SUPREME indoor rollator	19,00 €
312454	Bag for orange Jaguar indoor rollator	19,00 €
312465	Bag for purple Jaguar indoor rollator	19,00 €
312466	Bag for red Jaguar indoor rollator	19,00 €
31246A	Black hub cap for rear wheel of Jaguar rollator (312410-14)	0,50 €
312469	Black hub cap for rear wheel of Jaguar Supreme rollator (312415)	0,50 €
312468	Crutch holder for Jaguar consisting of clamp, screws and cup (complete set)	11,00 €
312457	Grab bar for Jaguar rollator	36,00 €
31246F	Grab bar for Jaguar SUPREME rollator	36,00 €
312458	Handle height adjustment clips for the Jaguar rollator (1 set)	15,00 €
312456	Red plastic clip for brake handle	3,25 €
312451	Tray for Jaguar indoor rollator, black	19,00 €
312467	Tray for Jaguar indoor rollator, creme	19,00 €
312461	Tray for Jaguar SUPREME indoor rollator	19,00 €

The Mobilex **DynaWalk** walking frame is a tool for disabled or elderly people who need additional support to maintain balance or stability while walking. The frame is made of powder coated aluminium and offers various adjustment functions: the armrests are adjustable in height, the angle of the handles is adjustable. The safety back bars are easily liftable. The width is easily adjustable through the cross joint. All settings can be done by clips without tools.

Walking frame Mobilex Bison	Item nr. 313001 Standard	Item nr. 313002 Brake
Max. load	135 kg	135 kg
Weight	12,5 kg	12,5 kg
Length	82 cm	82 cm
Width (adjustable)	67,5 - 75 cm	67,5 - 75 cm
Height of armrests (adjustable)	100 - 123 cm	100 - 123 cm
Max. height of the handles	136 cm	136 cm
Front brakes	2 lockable pedal brakes	2 lockable pedal brakes
Rear brakes	2 lockable pedal brakes, with friction	2 lockable brakes on the handles

Foto: RD1a



Mobilex DynaWalk Standard walking frame

Foto: RD1b

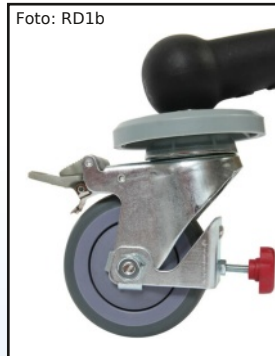

Rear wheel with brake
and friction

Foto: RD1c



Rear brake system -
manually operated

Foto: RD1d



Brake lever on handle on model 313002

DynaWalk walk trainer

Item nr.	Description	Foto	Price
313001	Dynawalk walk trainer	RD1A	560,00 €
313002	Dynawalk walk trainer with handbrakes	RD1D	680,00 €

Spare parts and accessories

Item nr.	Description	Price
313114	Adjustable support handle for Dynawalker with brake and cable, left	29,00 €
313113	Adjustable support handle for Dynawalker with brake and cable, right	29,00 €
313112	Adjustable support handle for Dynawalker, left	18,00 €
313111	Adjustable support handle for Dynawalker, right	18,00 €
313105	Belts for walking support and safety for Dynawalk, incl. brackets	55,00 €
313203	Caster set cabel operated for Dynawalk	19,00 €
313201	Caster set with foot-operated brake for Dynawalk standard	23,50 €
313202	Caster set with speed reducing device for Dynawalk	34,00 €
313212	Fenderwheel for Dynawalk	5,25 €
313115	Locking mechanism for height adjustment for Dynawalker, left	10,50 €
313116	Locking mechanism for height adjustment for Dynawalker, right	10,50 €
313101	Plastic bushing for height adjustent on Dynawalk walker	7,50 €
313211	Underarm pad for Dynawalker left side	43,50 €
313210	Underarm pad for Dynawalker, right side	43,50 €

The **Bison** walking frame is a mobility aid for learning and/or training of the active walking and can serve as support in case of balance disturbances. The frame is made of powder-coated aluminium and offers several adjustment functions: the arm rests can be easily adjusted in height by the gas spring support. The handles with the brake levers are angularly adjustable. All these settings can be performed without tools. The manual brakes act on the rear wheels and all four wheels are equipped with parking brakes. The narrow width also allows narrow passages.

Walking fram Mobilex Bison	Item nr. 313300
Width of the frame at the rear wheels	66,0 cm
Width of arm rests min. - max.	66,0 - 80,0 cm
Distance between handles	34,0 cm
Height min. - max.	102,2 - 143,0 cm
Length	86,0 cm
Weight	18,3 kg
Max. load	150 kg



Mobilex Bison walking frame

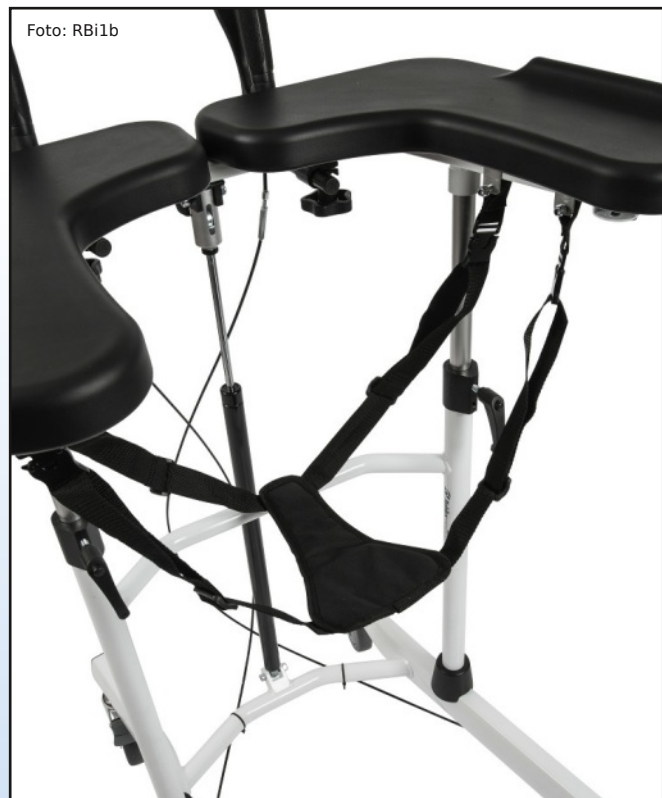

Mounted belt system (optional)

Accessories



Belt system for walking support



One-hand brake, complete cable set

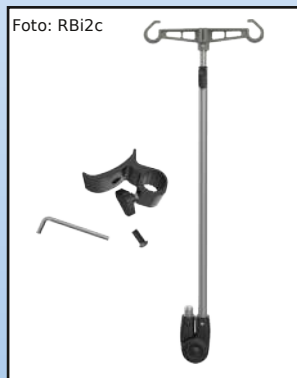

Holder for drainage or infusion bag



Holder for oxygen bottles

Bison walker

Item nr.	Description	Foto	Price
313300	Bison walker	RBI1A	920,00 €

Accessories

Item nr.	Description	Foto	Price
313380	Adjustable supporting seat belt	RBI2A	141,00 €
313384	Cable set for one-arm-brake for Bison Walker	RBI2B	126,00 €
313321	Fitting plate for oxygen bottle holder		72,00 €
313387	Holder for drainage for Bison walking frame	RBI2C	53,00 €
313386	Infusion rack for Bison walking frame	RBI2C	91,00 €
312321	Oxygen bottle holder	RS1P	60,00 €

Spare parts

Item nr.	Description	Price
313389	Brakehandle with tube for Bison walking frame	44,50 €
313383	Cable for Bison walker (can be used for both left and right side)	15,00 €
313382	Front wheel with directional and parking brake for Bison (1 pcs.)	64,00 €
313385	Gas spring for Bison walking frame	109,00 €
313388	PU pads for Bison walker (right and left)	160,00 €
313391	PU pads for Bison walker, left side	85,00 €
313390	PU pads for Bison walker, right side	85,00 €
313381	Rear wheel for Bison walking frame with direction brake (1 pcs.)	64,00 €

Koala shopping trolley

Stylish aluminium shopping trolley with large shopping bag made of tear-resistant nylon. The shopping trolley can be used as a seat when on the move by pressing a large button on the side. When stationary, the wheels are clear of the ground so it cannot roll away when used as a seat. When the Koala shopping trolley is moved across the floor, the trolley's curved structural bars make it easier to negotiate uneven surfaces. The trolley is rustproof and lightweight, yet sturdy and can be loaded with up to 110 kg.

In 2017, the trolley was awarded the Red Dot Award design prize.

Statement by the Jury: The integrated seat system and the attention to safety given to the trolley indicate sensitive consideration for the requirements of elderly people.



for short rest breaks

Koala Shoppingtrolley	Itemnr. 319001
Height unfolded	96 cm
Seat height	65 cm
Weight	2,5 kg
Load capacity seat (max. weight of user)	110 kg
Load capacity bag	30 kg

Koala shopping trolley

Item nr.	Description	Foto	Price
319001	Koala shopping trolley, blue and grey, with wheels and seat function, seat height 65 cm	RK01A	148,00 €
319002	Koala shopping trolley, orange and grey, with wheels and seat function, seat height 65 cm	RK02A	148,00 €

